

TM 11-6625-467-24P

TECHNICAL MANUAL

**ORGANIZATIONAL, DIRECT SUPPORT,
AND GENERAL SUPPORT MAINTENANCE
REPAIR PARTS AND SPECIAL TOOLS LIST**

FOR

**TEST SET, ELECTRONIC CIRCUIT
PLUG-IN UNIT AN/ARM-87 (NSN 6625-00-908-0358)**

HEADQUARTERS, DEPARTMENT OF THE ARMY

JUNE 1980

**ORGANIZATIONAL, DIRECT SUPPORT, AND GENERAL SUPPORT MAINTENANCE
 REPAIR PARTS AND SPECIAL TOOLS LISTS
 FOR
 TEST SET, ELECTRONIC CIRCUIT PLUG-IN UNIT AN/ARM-87
 (NSN 6625-00-908-0358)**

Current as of 28 January 1980

REPORTING OF ERRORS

You can help improve this manual. If you find any mistakes or know of a way to improve the procedures, please let us know. Mail your DA Form 2028 (Recommended Changes to Publications and Blank Forms), or DA Form 2028-2 located in back of this manual direct to: Commander, US Army Communications and Electronics Materiel Readiness Command, ATTN: DRSEL-ME-MQ, Fort Monmouth, NJ 07703.

In either case a reply will be furnished direct to you.

| | | Page | Illus Figure |
|----------|---|------|-----------------|
| S ECTION | I. INIRODUCIION | 1 | |
| | II. Repair Parts List | 5 | |
| Group | 00 Test Set, Electronic Circuit Plug-In Unit AN/ARM-87 | 5 | 1 |
| | Test Set, Electronic Circuit Plug-In Unit AN/ARM-87, Front Panel | 7 | 2 |
| | Test Set, Electronic Circuit Plug-In Unit AN/ARM-87, Chassis Assembly | 9 | 3 |
| | Test Set, Electronic Circuit Plug-In Unit AN/ARM-87, Chassis Assembly, Top View | 11 | 4 |
| | Test Set, Electronic Circuit Plug-In Unit AN/ARM-87, Chassis Assembly, Bottom View | 15 | 5 |
| | Test Set, Electronic Circuit Plug-In Unit AN/ARM-87, Chassis Assembly, Rear View | 17 | 6 |
| | Test Set, Electronic Circuit Plug-In Unit AN/ARM-87, Detector Module, Blower Assembly | 19 | 7 |
| | Test Set, Electronic Circuit Plug-In Unit AN/ARM-87, Transformer Bracket Assembly | 21 | 8 |
| | Test Set, Electronic Circuit Plug-In Unit AN/ARM-87, Plug-In Modules | 23 | 9 |
| | Test Set, Electronic Circuit Plug-In Unit AN/ARM-87, Load 500-kHz Fiberboard | 25 | 10 |
| | Test Set, Electronic Circuit Plug-In Unit AN/ARM-87, 150 cps Oscillator-Counter Board | 29 | 11 |
| | Test Set, Electronic Circuit Plug-In Unit AN/ARM-87, 1-kHz/10-kHz Oscillator | 33 | 12 |
| | Test Set, Electronic Circuit Plug-In Unit AN/ARM-87, 500-kHz FM Oscillator | 37 | 13 |
| | Test Set, Electronic Circuit Plug-In Unit AN/ARM-87, Amplifier Detector Audio Board | 41 | 14 |
| | Test Set, Electronic Circuit Plug-In Unit AN/ARM-87, +28 Volt Regulator | 45 | 15 |
| | Test Set, Electronic Circuit Plug-In Unit AN/ARM-87, HV Power Supply Board | 47 | 16 |
| | Test Set, Electronic Circuit Plug-In Unit AN/ARM-87, -28 Volt Regulator | 49 | 17 |
| | Test Set, Electronic Circuit Plug-In Unit AN/ARM-87, Load Assembly | 51 | 18 |
| | Test Set, Electronic Circuit Plug-In Unit AN/ARM-87, 3.975/5.925 -MHz Oscillator | 53 | 19 |
| | Test Set, Electronic Circuit Plug-In Unit AN/ARM-87, 30-MHz Oscillator | 55 | 20 |
| | Test Set, Electronic Circuit Plug-In Unit AN/ARM-87, 68-MHz Oscillator | 57 | 21 |
| | Test Set, Electronic Circuit Plug-In Unit AN/ARM-87, Amplifier Detector | 59 | 22 |
| | Test Set, Electronic Circuit Plug-In Unit AN/ARM-87, Board Extender | 61 | 23 |
| | 01 Cable Assemblies | 63 | 24 |
| | 02 Case Assembly | 67 | 25 |
| S ECTION | III. Special Tools List (Not applicable) | | |
| | IV. National Stock Number and Part Number Index | 68 | |

*This manual supersedes TM 11-6625-467-20P, 22 September 1972 and TM 11-6625-467-34P, 1 February 1973.

SECTION I INTRODUCTION

1. Scope

This manual lists spares and repair parts; special tools; special test, measurement, and diagnostic equipment (TMDE), and other special support equipment required for performance of organizational, direct support, and general support maintenance of the AN/ARM-87. It authorizes the requisitioning and issue of spares and repair parts as indicated by the source and maintenance codes.

2. General

This Repair Parts and Special Tools List is divided into the following sections:

a. *Section II.* Repair Parts List. A list of spares and repair parts authorized for use in the performance of maintenance. The list also includes parts which must be removed for replacement of the authorized parts. Parts lists are composed of functional groups in numeric sequence, with the parts in each group listed in figure and item number sequence.

b. *Section III.* Special Tools List. Not applicable.

c. *Section IV.* National Stock Number and Part Number Index. A list, in National item identification number (NIIN) sequence, of all National stock numbers (NSN) appearing in the listings, followed by a list, in alphameric sequence, of all part numbers appearing in the listings. National stock numbers and part numbers are cross-referenced to each illustration figure and item number appearance.

3. Explanation of Columns

a. Illustration. This column is divided as follows:

(1) *Figure number.* Indicates the figure number of the illustration on which the item is shown.

(2) *Item number.* The number used to identify item called out in the illustration.

b. *Source, Maintenance, and Recoverability (SMR) Codes.*

(1) *Source code.* Source codes indicate the manner of acquiring support items for maintenance, repair, or overhaul of end items. Source codes are entered in the first and second positions of the Uniform SMR Code format as follows:

| <i>Code</i> | <i>Definition</i> |
|-------------|--|
| PA | Item procured and stocked for anticipated or known usage. |
| XD | A support item that is not stocked. When required, item will be procured through normal supply channels. |

NOTE

Cannibalization or salvage may be used as a source of supply for any items source coded above except those coded XA and aircraft support items as restricted by AR 700-42.

(2) *Maintenance code.* Maintenance codes are assigned to indicate the levels of maintenance authorized to USE and REPAIR support items. The maintenance codes are entered in the third and fourth positions of the Uniform SMR Code format as follows:

(a) The maintenance code entered in the third position will indicate the lowest maintenance level authorized to remove, replace, and use the support item. The maintenance code entered in the third position will indicate one of the following levels of maintenance:

| <i>Code</i> | <i>Application/Explanation</i> |
|-------------|---|
| O | Support item is removed, replaced, used at the organizational level. |
| H | Support item is removed, replaced, used at the general support level. |

(b) The maintenance code entered in the fourth position indicates whether the item is to be repaired and identifies the lowest maintenance level with the capability to perform complete repair (i.e., all authorized maintenance functions). This position will contain one of the following maintenance codes:

| <i>Code</i> | <i>Application/Explanation</i> |
|-------------|---|
| H | The lowest maintenance level capable of complete repair of the support item is the general support level. |
| Z | Nonreparable. No repair is authorized. |

(3) *Recoverability code.* Recoverability codes are assigned to support items to indicate the disposition action on unserviceable items. The recoverability code is entered in the fifth position of the Uniform SMR Code format as follows:

| <i>Recoverability codes</i> | <i>Definition</i> |
|-----------------------------|--|
| Z | Nonreparable item. When unserviceable, condemn and dispose at the level indicated in position 3. |
| H | Reparable item. When uneconomically reparable, condemn and dispose at the general support level. |

c. *National Stock Number.* Indicates the National stock number assigned to the item and will be used for requisitioning purposes.

d. *Part Number.* Indicates the primary number used by the manufacturer (individual, company, firm, corporation, or Government activity), which controls the design and characteristics of the item by means of its engineering drawings, specifications, standards, and inspection requirements to identify an item or range of items.

NOTE

When a stock numbered item is requisitioned, the repair part received may have a different part number than the part being replaced.

e. *Federal Supply Code for Manufacturer (FSCM).*

The FSCM is a 5-digit numeric code listed in SB 708-41/-42 which is used to identify the manufacturer, distributor, or Government agency, etc.

f. Description. Indicates the Federal item name and, if required, a minimum description to identify the item.

g. Unit of Measure (U/M). Indicates the standard of the basic quantity of the listed item as used in performing the actual maintenance function. This measure is expressed by a two-character alphabetical abbreviation (e.g., ea, in, pr, etc). When the unit of measure differs from the unit of issue, the lowest unit of issue that will satisfy the required units of measure will be requisitioned.

h. Quantity Incorporated in Unit. Indicates the quantity of the item used in the breakout shown on the illustration figure, which is prepared for a functional group, subfunctional group, or an assembly. A "V" appearing in this column in lieu of a quantity indicates that no specific quantity is applicable, (e.g., shims, spacers, etc).

4. Special Information

The following publications pertain to the AN/ARM-87 and its components:

TM 11-6625-467-12, Test Set, Electronic Circuit Plug-In Unit AN/ARM-87

TM 11-6625-467-45, Test Set, Electronic Circuit Plug-In Unit AN/ARM-87

5. How to Locate Repair Parts

a. When National stock number or part number is unknown.

(1) *First.* Using the table of contents, determine the functional group within which the item belongs. This is necessary since illustrations are prepared for functional groups and listings are divided into the same groups.

(2) *Second.* Find the illustration covering the functional group to which the item belongs.

(3) *Third.* Identify the item on the illustration and note the illustration figure and item number of the item.

(4) *Fourth.* Using the Repair Parts Listing, find the figure and item number noted on the illustration.

b. When National stock number or part number is known.

(1) *First.* Using the Index of National Stock Numbers and Part Numbers, find the pertinent National stock number or part number. This index is in NIIN sequence followed by a list of part numbers in alphameric sequence, cross-referenced to the illustration figure number and item number.

(2) *Second.* After finding the figure and item number, locate the figure and item number in the repair parts list.

6. Abbreviations

Not applicable.

(Next printed page is 4.1)

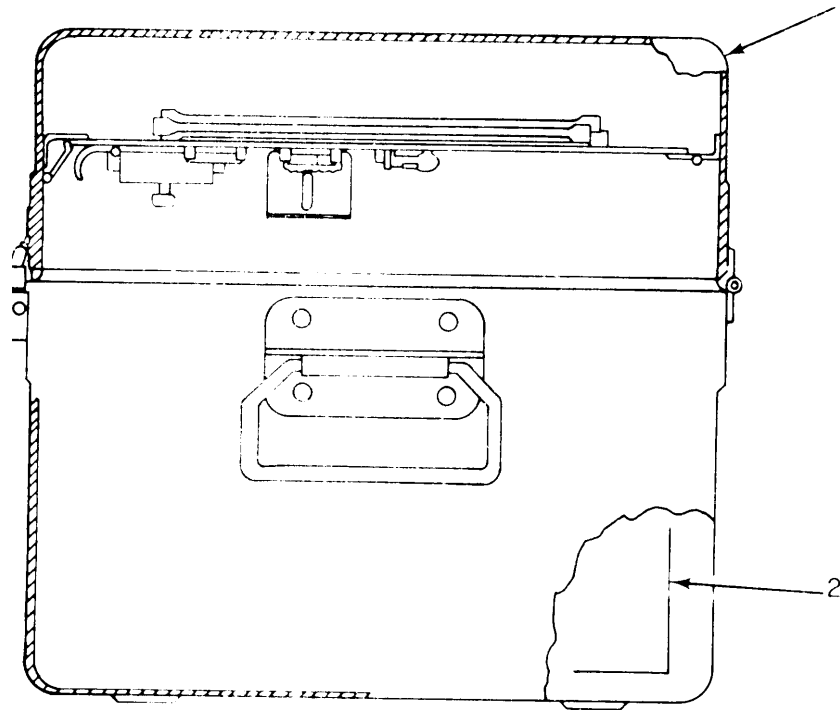

EL5EL001

Figure 1. Test Set, Electronic Circuit Plug-In Unit AN/ARM-87 (SHEET 1 OF 2)

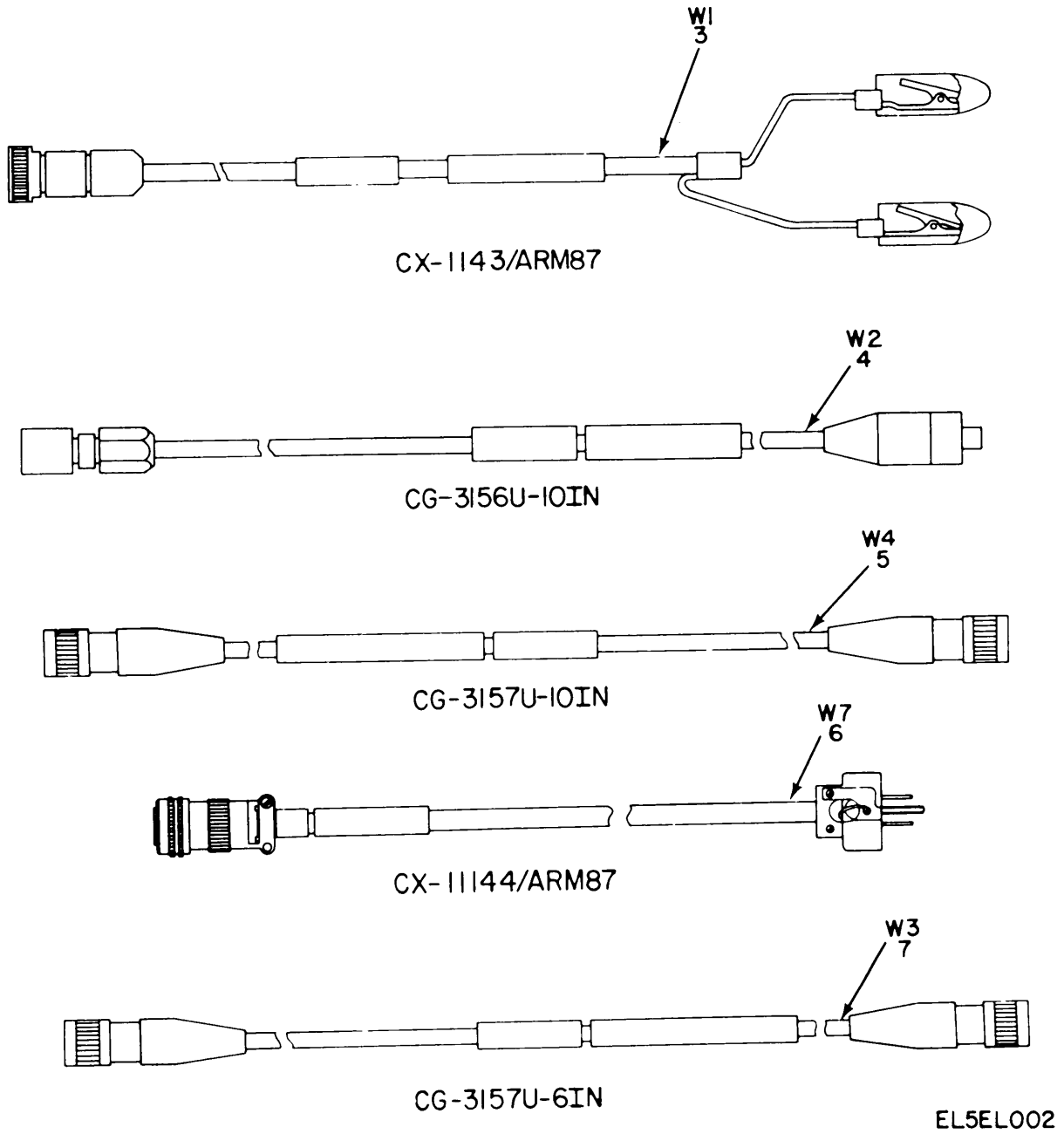
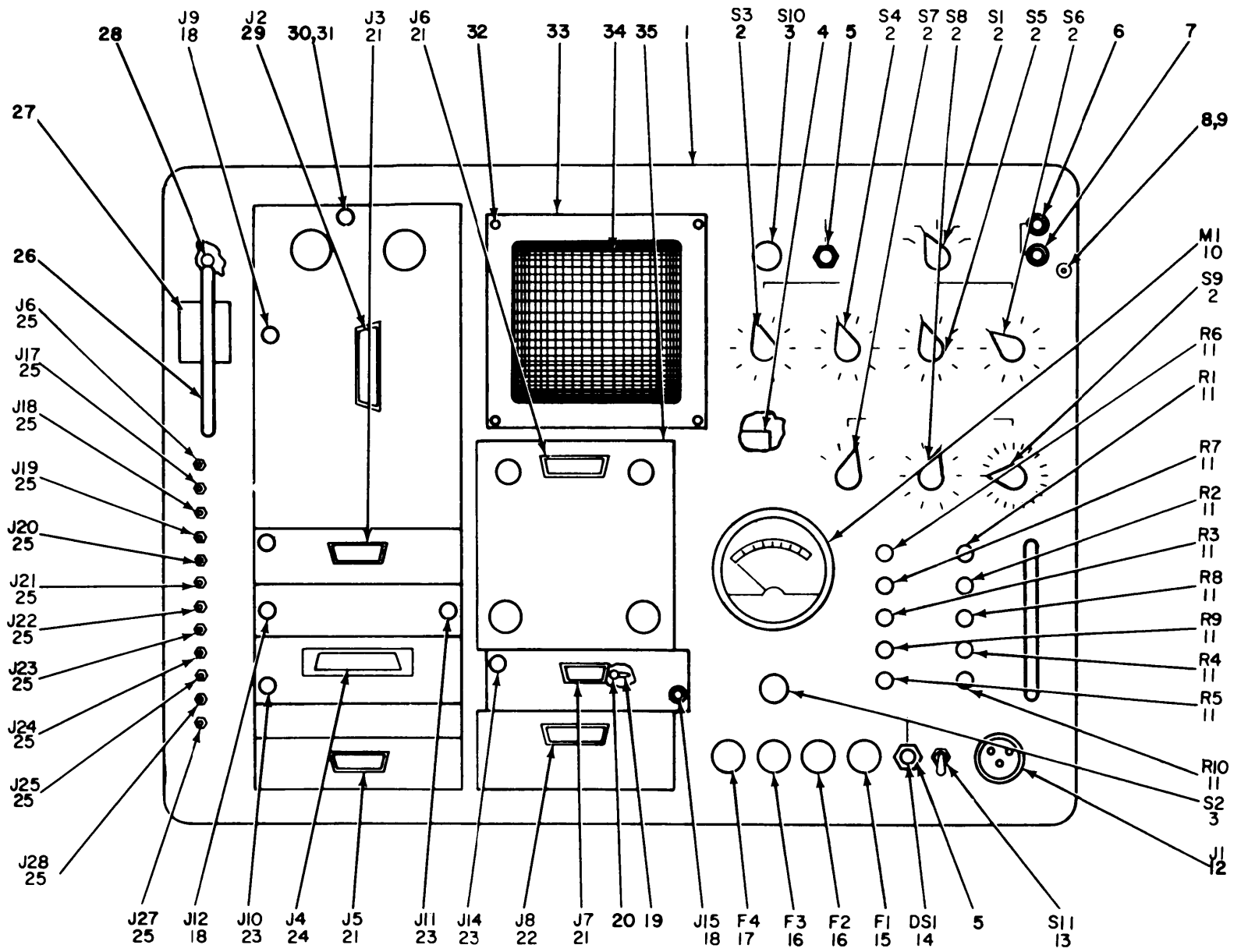

Figure 1. Test Set, Electronic Circuit Plug-In Unit AN/ARM-87 (Sheet 2 of 2).

| SECTION II | | | | | | TM11-6625-467-24P | | | |
|--------------|------|----------|------------------|----------------|--|---------------------|-----|------|--|
| (1) | (2) | (3) | (4) | (5) | (6) | (7) | (8) | | |
| ILLUSTRATION | | | | | | | QTY | | |
| (A) | (B) | NATIONAL | | | DESCRIPTION | | INC | | |
| FIG | ITEM | STOCK | PART | FSCM | | USABLE ON CODE | U/M | IN | |
| NO | NO | CODE | NUMBER | | | | | UNIT | |
| | | | | | GROUP 00 TEST SET,ELECTRONIC CIRCUIT PLUG- | | | | |
| | | | | | IN UNIT AN/ARM-87 | | | | |
| 1 | 1 | XDHHH | SME508455 | 80063 | CASE ASSEMBLY | | EA | 1 | |
| 1 | 2 | XDHHH | SME508452 | 80063 | CHASSIS ASSEMBLY | | EA | 1 | |
| 1 | 3 | PAHHH | 6625-00-902-7575 | CX1143/ARM-87 | 80058 | CABLE ASSEMBLY,RF | EA | 1 | |
| 1 | 4 | PAHHH | 5995-00-902-8502 | CG3156U(10IN) | 80058 | CABLE ASSEMBLY,RF | EA | 1 | |
| 1 | 5 | PAHHH | 5995-00-902-2071 | CG3157/U-10IN | 80058 | CABLE ASSEMBLY,RF | EA | 2 | |
| 1 | 6 | PAHHH | 5995-00-902-4146 | CX11144/ARM-87 | 80058 | CABLE ASSY,PWR ELEC | EA | 1 | |
| 1 | 7 | PAHHH | 5995-00-902-2078 | CG3157U6IN | 80058 | CABLE ASSEMBLY,ELEC | EA | 1 | |
| | | | | | PIECE PART BREAKDOWN SAME AS CG3157/U-10IN | | | | |



EL5EL003

Figure 2. Test Set, Electronic Circuit Plug-In Unit AN/ARM-87, Front Panel.

| SECTION II (1) ILLUSTRATION (A) (B) FIG ITEM NO NO | | (2) SMR CODE | (3) NATIONAL STOCK NUMBER | (4) PART NUMBER | (5) FSCM | TM11-6625-467-24P (6) DESCRIPTION | USABLE ON CODE | (7) U/M | (8) QTY INC IN UNIT |
|---|----|--------------------|------------------------------------|-----------------------|-------------|---|----------------|------------|---------------------------------|
| 2 | 1 | XDHZZ | | SME508456 | 80063 | PANEL,FRONT | | EA | 1 |
| 2 | 2 | PAOZZ | 5355-00-616-9604 | MS91528-1P28 | 96906 | KNOB | | EA | 8 |
| 2 | 3 | XDHZZ | | SMD508436 | 80063 | SWITCH,PUSH | | EA | 2 |
| 2 | 4 | XDHZZ | | SMB508329 | 80063 | LABEL | | EA | 3 |
| 2 | 5 | PAOZZ | 6240-00-155-7836 | MS25237-327 | 96906 | LAMP,INCANDESCENT | | EA | 2 |
| 2 | 6 | PAHZZ | 5940-00-817-4880 | SMC508361-2 | 80063 | POST,SPACING | | EA | 1 |
| 2 | 7 | XDHZZ | | SMC508361-1 | 80063 | POST SPACING | | EA | 1 |
| 2 | 8 | PAHZZ | 5305-00-770-2580 | MS51959-16 | 96906 | SCREW,MACHINE | | EA | 2 |
| 2 | 9 | XDHZZ | | SMC504554-2 | 80063 | WASHER,FLAT | | EA | 3 |
| 2 | 10 | XDHZZ | | SMD508319 | 80063 | AMMETER | | EA | 1 |
| 2 | 11 | PAOZZ | 5355-00-813-2078 | MS91528-0D18 | 96906 | KNOB | | EA | 10 |
| 2 | 12 | PAHZZ | 5935-00-912-8997 | MS3112E12-3PY | 96906 | CONNECTOR,RECEPTACL | | EA | 1 |
| 2 | 13 | PAHZZ | 5930-00-655-1575 | MS35059-22 | 96906 | SWITCH,TOGGLE | | EA | 1 |
| 2 | 14 | PAOZZ | 6210-00-169-5157 | SMC508425-2 | 80063 | LENS,LIGHT | | EA | 1 |
| 2 | 15 | XDOZZ | | SMC508344-3 | 80063 | FUSE,CARTRIDGE | | EA | 1 |
| 2 | 16 | PAOZZ | 5920-00-280-4465 | F02A250V1AS | 81349 | FUSE,CARTRIDGE | | EA | 2 |
| 2 | 17 | XDOZZ | | SMC508344-1 | 80063 | FUSE,CARTRIDGE | | EA | 1 |
| 2 | 18 | XDHZZ | | SMC504067 | 80063 | CONNECTOR,RCPT,ELEC | | EA | 3 |
| 2 | 19 | XDHZZ | | SMC504133-3 | 80063 | TERMINAL,LUG | | EA | 6 |
| 2 | 20 | XDHZZ | | MS50957-5 | 96906 | SCREW,MACHINE | | EA | 2 |
| 2 | 21 | XDOZZ | | SMD508360-2 | 80063 | CONNECTOR,RECPT,ELEC | | EA | 4 |
| 2 | 22 | XDHZZ | | SMD504863 | 80063 | CONNECTOR,RCPT,ELEC | | EA | 1 |
| 2 | 23 | XDHZZ | | SMC504301 | 80063 | CONNECTOR,RCPT,ELEC | | EA | 3 |
| 2 | 24 | XDHZZ | | SMD504366 | 80063 | CONNECTOR,RCPT,ELEC | | EA | 1 |
| 2 | 25 | XDHZZ | | SMC504064 | 80063 | CONNECTOR,RCPT,ELEC | | EA | 12 |
| 2 | 26 | PAHZZ | 5340-00-840-0954 | MS39087-4 | 96906 | HANDLE,BOW | | EA | 2 |
| 2 | 27 | XDHZZ | | SMD508447 | 80063 | PLATE,IDENT | | EA | 1 |
| 2 | 28 | PAHZZ | 5305-00-071-1323 | MS51960-66 | 96906 | SCREW,MACHINE | | EA | 4 |
| 2 | 29 | XDHZZ | | DCMP37S | 71468 | CONNECTOR,RCPT,ELEC | | EA | 1 |
| 2 | 30 | PAHZZ | 5305-00-054-5638 | MS51957-4 | 96906 | SCREW,MACHINE | | EA | 10 |
| 2 | 31 | PAHZZ | 5310-00-225-5328 | 310-0048-00 | 79807 | WASHER,FLAT | | EA | 16 |
| 2 | 32 | PAHZZ | 5305-00-054-6651 | MS51957-27 | 96906 | SCREW,MACHINE | | EA | 11 |
| 2 | 33 | XDHZZ | | SMC508414 | 80063 | RETAINER,FILTER | | EA | 1 |
| 2 | 34 | XDHZZ | | SMC508467 | 80063 | FILTER,AIR | | EA | 1 |
| 2 | 35 | XDHZZ | | SMC508411-1 | 80063 | PLATE,MOUNTING | | EA | 2 |

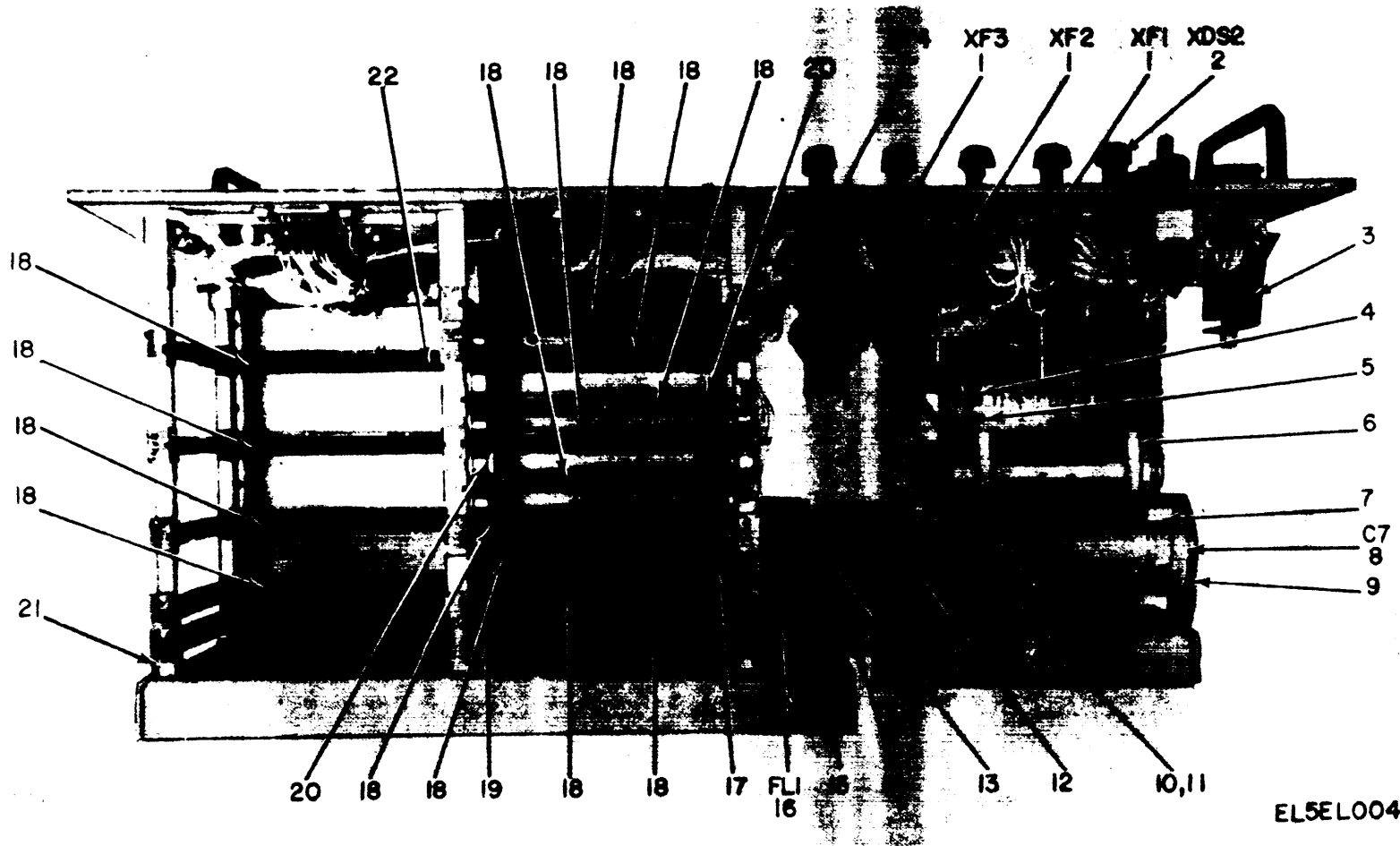

EL5EL004

Figure 3. Test Set, Electronic Circuit Plug-In Unit AN/ARM-87, Chassis Assembly.

| SECTION II | | TM11-6625-467-24P | | | | | | |
|--------------|------|-------------------|--------------|-------|---------------------|----------------|-------|--|
| (1) | (2) | (3) | (4) | (5) | (6) | (7) | (8) | |
| ILLUSTRATION | | | | | | | | |
| (A) | (B) | NATIONAL | PART | | DESCRIPTION | USABLE ON CODE | U/M | |
| FIG | ITEM | STOCK | NUMBER | FSCM | | | | |
| NO | NO | NUMBER | | | | | INC | |
| | | | | | | | IN | |
| | | | | | | | UNIT | |
| 3 | 1 | | SMC508373 | 80063 | FUSEHOLDER | | EA 4 | |
| 3 | 2 | | SMD508431 | 80063 | LIGHT INDICATOR | | EA 1 | |
| 3 | 3 | 5930-00-615-3630 | 4AC1 | 91929 | SWTICH,PUSH-PULL | | EA 1 | |
| 3 | 4 | | SMB508351 | 96906 | SCREW,MACHINE | | EA 2 | |
| 3 | 5 | | AN936A108 | 88044 | WASHER,FLAT | | EA 12 | |
| 3 | 6 | | SMD508385-2 | 80063 | BRACKET,MOUNTING | | EA 1 | |
| 3 | 7 | | SMC508306 | 80063 | CLIP,ELECTRICAL | | EA 2 | |
| 3 | 8 | | SMD508424-1 | 80063 | CAPACITOR,FXD,ELCLT | | EA 1 | |
| 3 | 9 | | SMC508400 | 80063 | RETAINER | | EA 1 | |
| 3 | 10 | 5305-00-054-6659 | MS51957-35 | 96906 | SCREW,MACHINE | | EA 4 | |
| 3 | 11 | 5310-00-540-8119 | MS15795-305 | 96906 | WASHER,FLAT | | EA 6 | |
| 3 | 12 | | SMD508343 | 80063 | REACTOR | | EA 1 | |
| 3 | 13 | | SMD508334 | 80063 | RELAY,ARMATURE | | EA 1 | |
| 3 | 14 | 5325-00-074-3301 | MS21266-2N | 96906 | GROMMET,NONMETALLIC | | EA 1 | |
| 3 | 15 | | SMC508345 | 80063 | CONNECTOR,RECT,ELEC | | EA 2 | |
| 3 | 16 | | SMD508355 | 80063 | FILTER,HIGH,PASS | | EA 1 | |
| 3 | 17 | | SMD508410 | 80063 | GUIDE,CARD | | EA 1 | |
| 3 | 18 | | SMD508328 | 80063 | CONNECTOR,PLUG,ELEC | | EA 13 | |
| 3 | 19 | | SMD508404 | 80063 | GUIDE,CARD | | EA 1 | |
| 3 | 20 | 5365-00-181-1371 | 762-2169-001 | 13499 | SPACER,CONNECTOR | | EA 3 | |
| 3 | 21 | | SMD508406 | 80063 | GUIDE,CARD | | EA 1 | |
| 3 | 22 | | SMC508323 | 80063 | KEY | | EA 52 | |

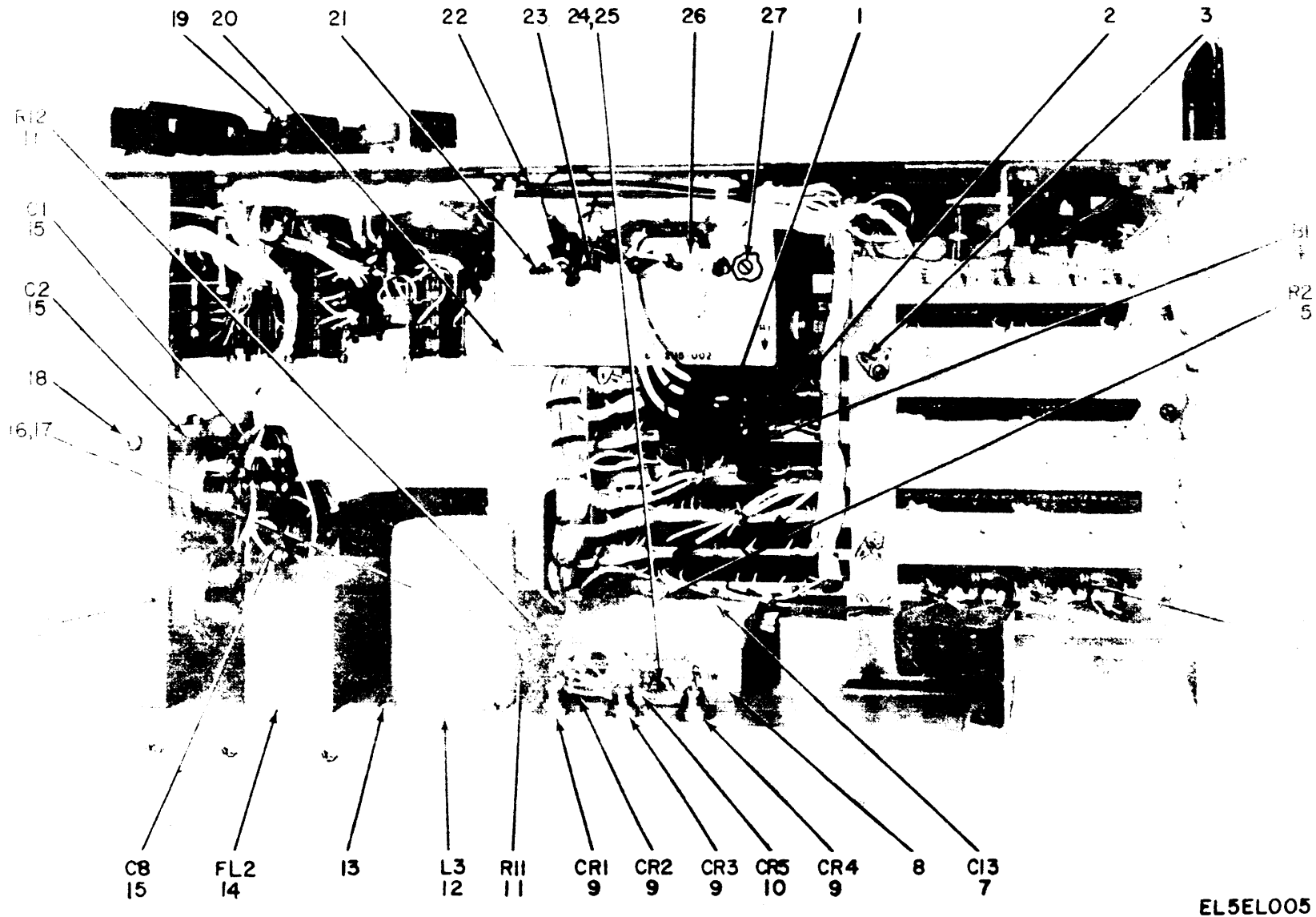

EL5EL005

Figure 4. Test Set, Electronic Circuit Plug-In Unit AN/ARM-87, Chassis Assembly, Top View.

| SECTION II (1) ILLUSTRATION (A) (B) FIG ITEM NO NO | | (2) SMR CODE | (3) NATIONAL STOCK NUMBER | (4) PART NUMBER | (5) FSCM | TM11-6625-467-24P (6) DESCRIPTION | (7) USABLE ON CODE U/M | (8) QTY INC IN UNIT |
|---|----|--------------------|------------------------------------|-----------------------|-------------|---|---------------------------|---------------------------------|
| 4 | 1 | XDHZZ | | 10954-325 | 06773 | CLAMP,RIM,CLENCH | EA | 3 |
| 4 | 2 | PAHZZ | 5310-00-281-9845 | 68NM40 | 72962 | NUT,SELF-LOCKING,HE | EA | 2 |
| 4 | 3 | XDHZZ | | SMB508325-1 | 80063 | TERMINAL,LUG | EA | 11 |
| 4 | 4 | XDHZZ | | SMC508358 | 80063 | FAN,AXIAL | EA | 1 |
| 4 | 5 | PAHZZ | 5905-00-229-2620 | RC20GF223K | 81349 | RESISTOR,FXD,CMPNS | EA | 1 |
| 4 | 6 | XDHZZ | | SMC508324 | 80063 | COIL,RADIO,FREQ | EA | 1 |
| 4 | 7 | PAHZZ | 5910-00-433-5446 | CS138E1064 | 81349 | CAPACITOR,FXD,ELCLT | EA | 1 |
| 4 | 8 | XDHZZ | | SMD508464 | 80063 | ATTEUNATOR,FXD | EA | 1 |
| 4 | 9 | PAHZZ | 5961-00-226-3717 | 1N1202 | 81349 | SEMICONDUCTOR,DIODE | EA | 4 |
| 4 | 10 | PAHZZ | 5961-00-899-9347 | 1N2988A | 81349 | SEMICONDUCTOR,DIODE | EA | 1 |
| 4 | 11 | PAHZZ | 5905-00-855-6140 | RE65GR499 | 81349 | RESISTOR,FXD,WW | EA | 2 |
| 4 | 12 | XDHZZ | | SMD508466 | 80063 | REACTOR | EA | 1 |
| 4 | 13 | PAHZZ | 5305-00-054-6652 | MS51957-28 | 96906 | SCREW,MACHINE | EA | 6 |
| 4 | 14 | XDHZZ | | SMD508333 | 96906 | FILTER HIGH PASS | EA | 1 |
| 4 | 15 | XDHZZ | | SMD508424-2 | 80063 | CAPACITOR,FXD,ELCLT | EA | 4 |
| 4 | 16 | XDHZZ | | SMC508562 | 80063 | NUT,PLAIN,HEXAGON | EA | 2 |
| 4 | 17 | PAHZZ | 5305-00-054-5639 | MS51957-5 | 96906 | SCREW,MACHINE | EA | 2 |
| 4 | 18 | XDHZZ | | SMB508351 | 80063 | SCREW,MACHINE | EA | 10 |
| 4 | 19 | XDHZZ | | SMC508425-1 | 80063 | LENS,IND,LIGHT | EA | 1 |
| 4 | 20 | XDHZZ | | SME508444 | 80063 | FAN,MOUNT | EA | 1 |
| 4 | 21 | PAHZZ | 5821-00-704-1602 | 7274633 | 16758 | MAINTENANCE KIT,ELE | EA | 12 |
| 4 | 22 | XDHZZ | | 762115001 | 13499 | BLOWER,MOUNT | EA | 1 |
| 4 | 23 | PAHZZ | 5310-00-062-0906 | TW516-10 | 08289 | WASHER,FLAT | EA | 2 |
| 4 | 24 | PAHZZ | 5305-00-054-6654 | MS51957-30 | 96906 | SCREW,MACHINE | EA | 8 |
| 4 | 25 | PAHZZ | 5310-00-011-1041 | MS35338-79 | 96906 | WASHER,SPLIT | EA | 21 |
| 4 | 26 | XDHZZ | | SMC508314 | 80063 | CLAMP,SYNC | EA | 3 |
| 4 | 27 | PAHZZ | 5305-00-054-6653 | MS51957-29 | 96906 | SCREW,MACHINE | EA | 9 |

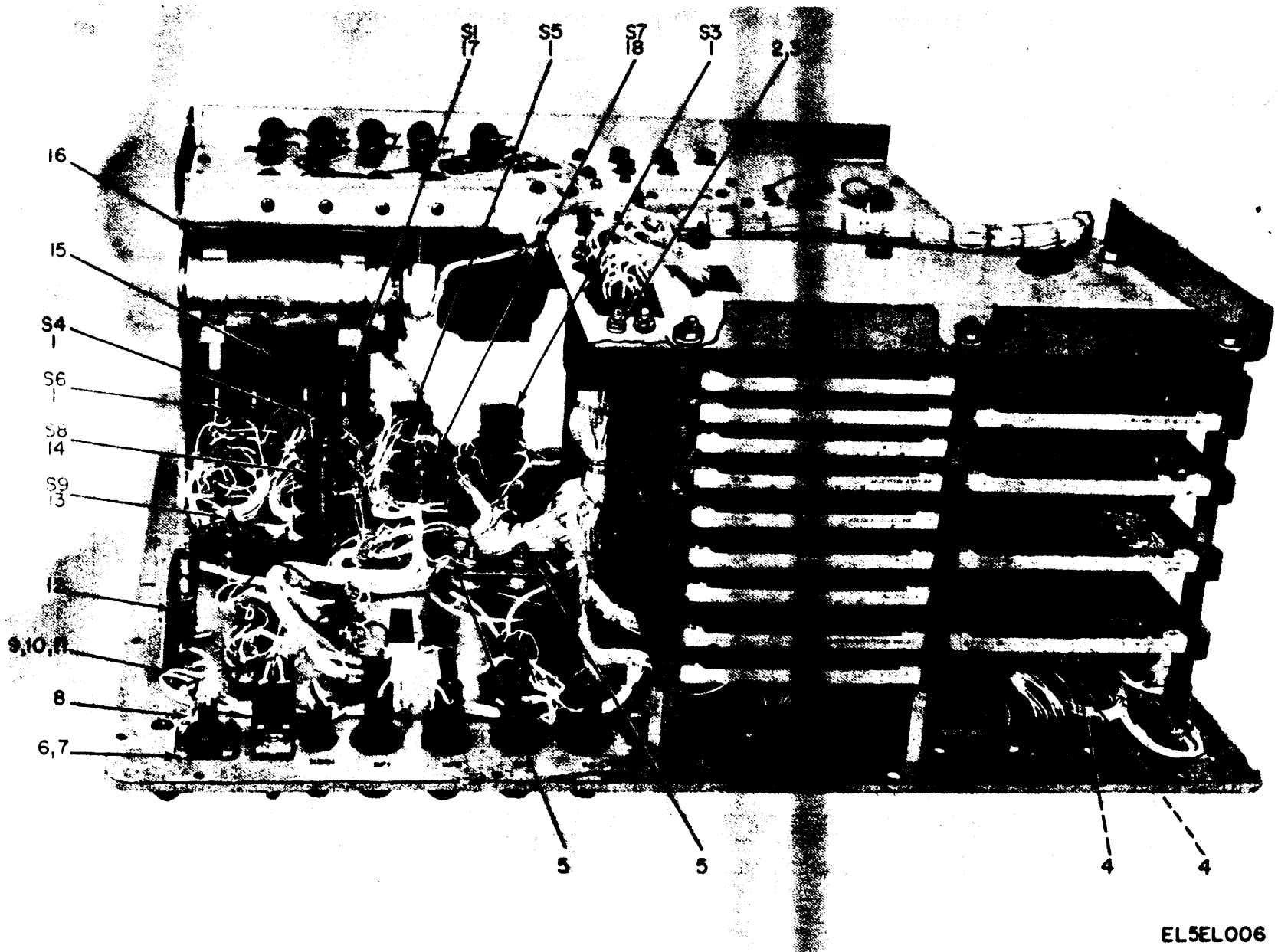

EL5EL006

Figure 5. Test Set, Electronic Circuit Plug-In Unit AN/ARM-87, Chassis Assembly, Bottom View (Sheet 1 of 2).

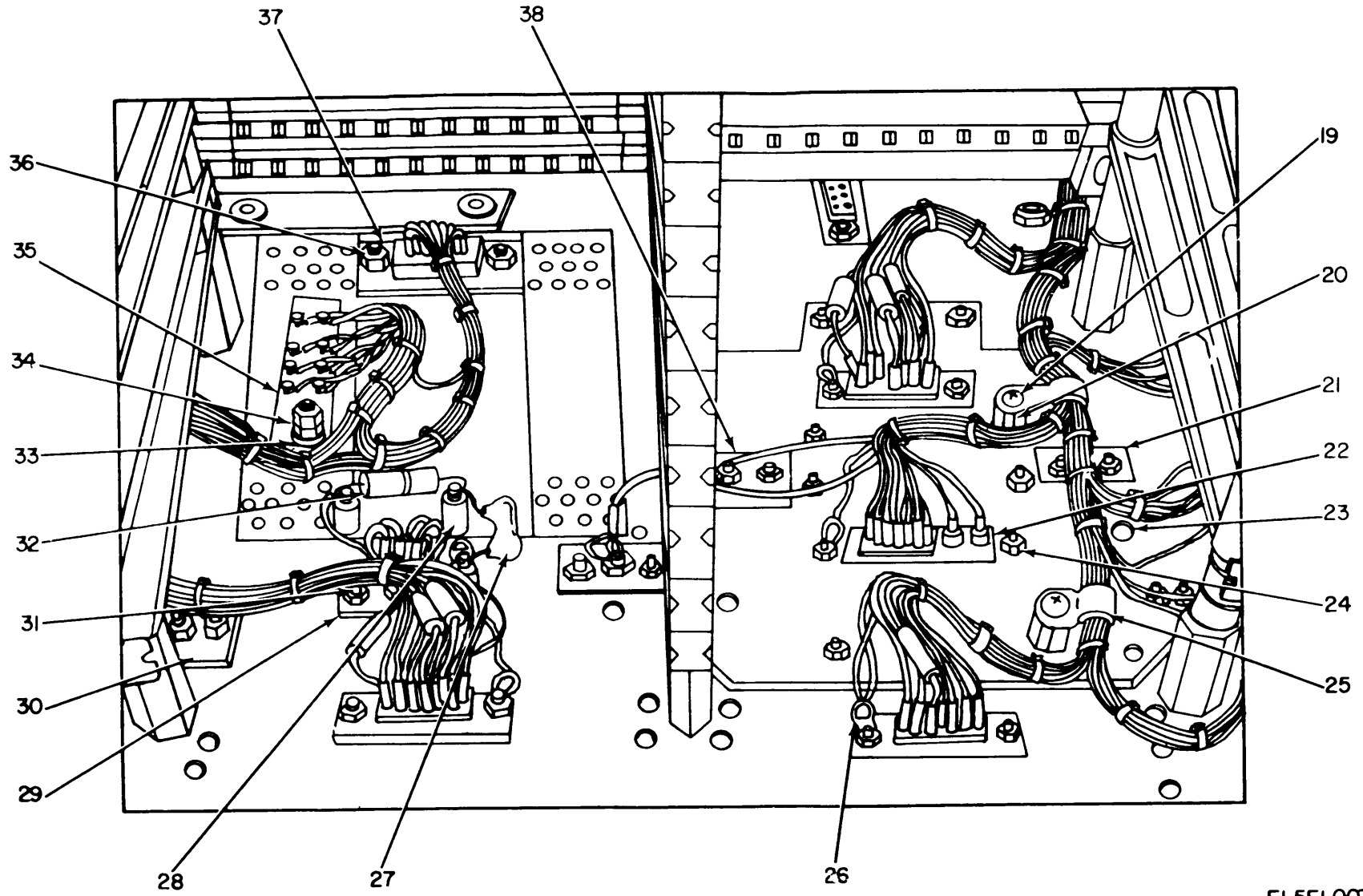

EL5ELO07

Figure 5. Test Set, Electronic Circuit Plug-In Unit AN/ARM-87, Chassis Assembly, Bottom View (Sheet 2 of 2).

| SECTION II | | TM11-6625-467-24P | | | | | | |
|--------------|------|-------------------|------------------|--------------|-----------------------|----------------------|-------|--|
| (1) | (2) | (3) | (4) | (5) | (6) | (7) | (8) | |
| ILLUSTRATION | | | | | DESCRIPTION | | QTY | |
| (A) | (B) | NATIONAL | PART | FSCM | | USABLE ON CODE | INC | |
| FIG | ITEM | STOCK | NUMBER | | | | IN | |
| NO | NO | NUMBER | NUMBER | | | | UNIT | |
| 5 | 1 | XDHZZ | SMD508560 | 80063 | SWITCH, ROTARY | EA | 4 | |
| 5 | 2 | PAHZZ | 5305-00-054-5649 | MS51957-15 | 96906 | SCREW, MACHINE | EA 6 | |
| 5 | 3 | PAHZZ | 5310-00-782-1349 | MS15795-304 | 96906 | WASHER, FLAT | EA 4 | |
| 5 | 4 | XDHZZ | SMD508341-1 | 80063 | CONNECTOR, RCPT, ELEC | EA | 2 | |
| 5 | 5 | XDHZZ | SMB508541 | 80063 | TERMINAL, LUG | EA | 6 | |
| 5 | 6 | PAHZZ | 5305-00-054-5649 | MS51957-15 | 96906 | SCREW, MACHINE | EA 4 | |
| 5 | 7 | PAHZZ | 5310-00-281-9845 | MS20365D440A | 96906 | NUT, PLAIN, HEXAGON | EA 16 | |
| 5 | 8 | XDHZZ | SMC508537 | 80063 | TERMINAL, LUG | EA | 5 | |
| 5 | 9 | XDHZZ | SMB508393 | 80063 | WASHER, FLAT | EA | 7 | |
| 5 | 10 | XDHZZ | MS50957-7 | 96906 | SCREW, MACHINE | EA | 3 | |
| 5 | 11 | XDHZZ | SMC504562 | 80063 | NUT, PLAIN, HEXAGON | EA | 21 | |
| 5 | 12 | XDHZZ | SMC508317 | 80063 | BRACKET, MOUNTING | EA | 1 | |
| 5 | 13 | XDHZZ | SMD508443 | 80063 | SWITCH, ROTARY | EA | 1 | |
| 5 | 14 | XDHZZ | SMD508440-2 | 80063 | SWITCH, ROTARY | EA | 1 | |
| 5 | 15 | XDHZZ | SMD508382 | 80063 | SUPPORT ASSEMBLY | EA | 1 | |
| 5 | 16 | XDHZZ | SMD508385-1 | 80063 | BRACKET, MOUNTING | EA | 1 | |
| 5 | 17 | XDHZZ | SMD508438 | 80063 | SWITCH, ROTARY | EA | 1 | |
| 5 | 18 | XDHZZ | SMD508440-1 | 80063 | SWITCH, ROTARY | EA | 1 | |
| 5 | 19 | XDHZZ | 310004500 | 79807 | WASHER, FLAT | EA | 1 | |
| 5 | 20 | PAHZZ | 5340-00-722-8713 | 5409168003 | 13499 | POST, ELECTRICAL | EA 2 | |
| 5 | 21 | XDHZZ | SMD508365-2 | 80063 | CLAMP, LOOP | EA | 1 | |
| 5 | 22 | XDHZZ | SMC508411-2 | 80063 | PLATE, MOUNTING | EA | 7 | |
| 5 | 23 | PAHZZ | 5340-00-368-4708 | MS122079 | 96906 | INSERT, SCREW THREAD | EA 4 | |
| 5 | 24 | XDHZZ | MS20365D632A | 96906 | NUT, PLAIN, HEXAGON | EA | 12 | |
| 5 | 25 | XDHZZ | SMC508365-1 | 80063 | CLAMP LOOP | EA | 1 | |
| 5 | 26 | XDHZZ | SMC504699 | 80063 | TERMINAL, LUG | EA | 5 | |
| 5 | 27 | PAHZZ | 5910-00-952-6432 | CM06F561J03 | 81349 | CAPACITOR, FXD, MICA | EA 1 | |
| 5 | 28 | XDHZZ | RIMT16M | 91663 | TERMINAL, STUD | EA | 2 | |
| 5 | 29 | XDHZZ | SMC508377-2 | 80063 | PLATE, MOUNTING | EA | 2 | |
| 5 | 30 | XDHZZ | SMC508377-1 | 80063 | PLATE, MOUNTING | EA | 5 | |
| 5 | 31 | PAHZZ | 5305-00-829-0105 | MS51960-6 | 96906 | SCREW, MACHINE | EA 4 | |
| 5 | 32 | PAHZZ | 5950-00-070-7642 | MS90541-04 | 96906 | COIL, RADIO, FREQ | EA 1 | |
| 5 | 33 | XDHZZ | SMC504554-2 | 80063 | WASHER, FLAT | EA | 3 | |
| 5 | 34 | PAHZZ | 5310-00-271-4642 | MS35649-44 | 96906 | NUT, PLAIN, HEXAGON | EA 2 | |
| 5 | 35 | XDHZZ | SMC508337 | 80063 | TERMINAL, BOARD | EA | 1 | |
| 5 | 36 | PAHZZ | 5305-00-763-7827 | MS51959-18 | 96906 | SCREW, MACHINE | EA 2 | |
| 5 | 37 | XDHZZ | SMC508375 | 80063 | PLATE, MOUNTING | EA | 2 | |
| 5 | 38 | XDHZZ | SMC508398-2 | 80063 | PLATE, MOUNTING | EA | 4 | |

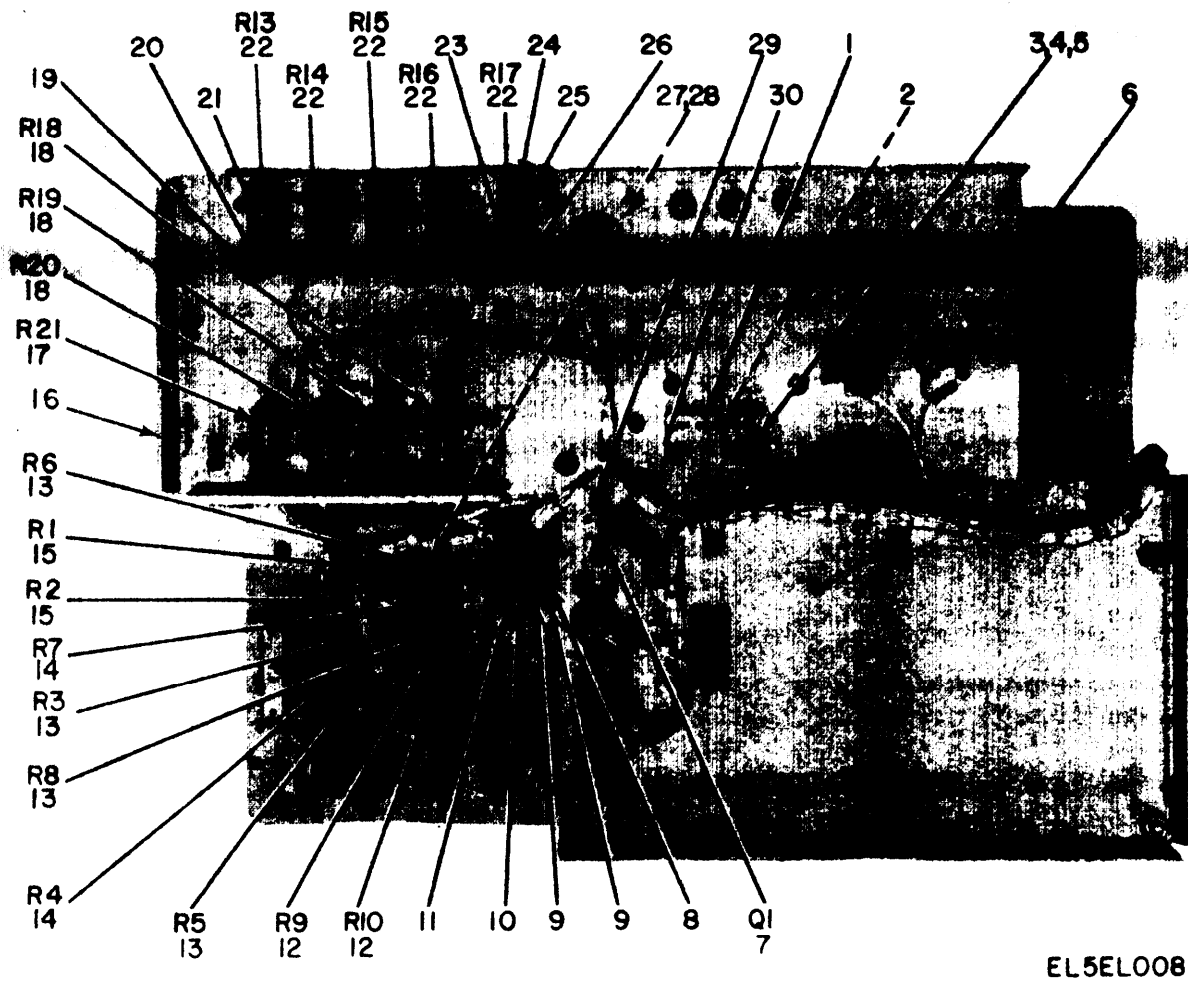
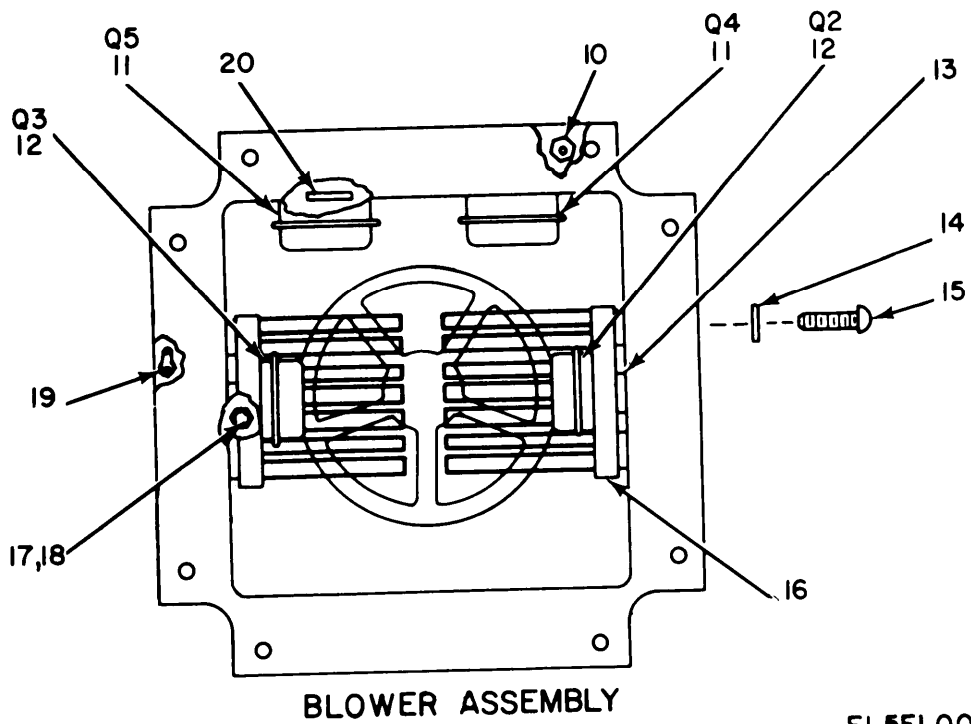
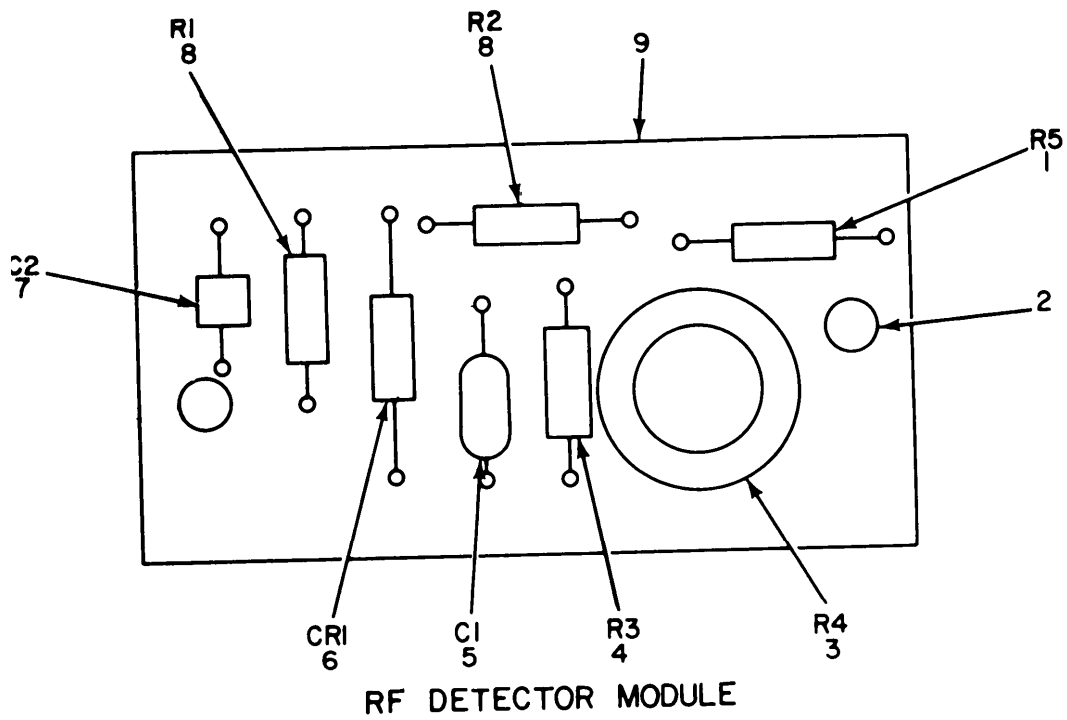

Figure 6. Test Set, Electronic Circuit Plug-In Unit AN/ARM-87, Chassis Assembly, Rear View.

| SECTION II | | TM11-6625-467-24P | | | | | | |
|--------------|------|-------------------|---------------|-------|---------------------|----------------|------|----|
| (1) | (2) | (3) | (4) | (5) | (6) | (7) | (8) | |
| ILLUSTRATION | | | | | | | | |
| (A) | (B) | NATIONAL | PART | FSCM | DESCRIPTION | USABLE ON CODE | U/M | |
| FIG | ITEM | STOCK | NUMBER | | | | | |
| NO | NO | NUMBER | | | | | INC | |
| | | | | | | | IN | |
| | | | | | | | UNIT | |
| 6 | 1 | | SMC508405 | 80063 | SHIELD | | EA | 1 |
| 6 | 2 | | SMC508499 | 80063 | CIRCUIT CARD ASSY | | EA | 1 |
| 6 | 3 | | SMB508386 | 80063 | SPACER,SLEEVE | | EA | 2 |
| 6 | 4 | 5305-00-054-5653 | MS51957-19 | 96906 | SCREW,MACHINE | | EA | 2 |
| 6 | 5 | 5310-00-933-8118 | MS35338-78 | 96906 | WASHER,SPLIT | | EA | 2 |
| 6 | 6 | | 2104-02-2520N | 78189 | TERMINAL,LUG | | EA | 4 |
| 6 | 7 | 5961-00-081-4816 | 2N1485 | 81349 | TRANSISTOR | | EA | 1 |
| 6 | 8 | | SMC508508 | 80063 | PW,BOARD | | EA | 1 |
| 6 | 9 | 5961-00-728-3444 | 1N3730 | 81349 | SEMICONDUCTOR,DIODE | | EA | 2 |
| 6 | 10 | | AN936A416B | 88044 | WASHER,LOCK | | EA | 2 |
| 6 | 11 | | SMC508509 | 80063 | CIRCUIT CARD ASSY | | EA | 1 |
| 6 | 12 | | RV6NAYSL503B | 81349 | RESISTOR,VARIABLE | | EA | 2 |
| 6 | 13 | 5905-01-013-8264 | RV6NAYSD102B | 81349 | RESISTOR,VARIABLE | | EA | 4 |
| 6 | 14 | | RV6NAYSK103B | 81349 | RESISTOR,VARIABLE | | EA | 2 |
| 6 | 14 | 5905-00-721-4124 | RV6NAYSL2528 | 81349 | RESISTOR,VARIABLE | | EA | 2 |
| 6 | 16 | | SME508451 | 80063 | PANEL,MOUNTING | | EA | 1 |
| 6 | 17 | 5905-00-577-7493 | RW31V562 | 81349 | RESISTOR,FXD,WW | | EA | 1 |
| 6 | 18 | 5905-00-892-1337 | RW31V390 | 81349 | RESISTOR,FXD,WW | | EA | 3 |
| 6 | 19 | | MS51057-29 | 96906 | SCREW,MACHINE | | EA | 9 |
| 6 | 20 | | 302034700 | 91500 | WASHER,INSULATION | | EA | 9 |
| 6 | 21 | | SMC508304 | 80063 | POST,SPACING | | EA | 9 |
| 6 | 22 | 5905-00-843-2030 | RW31V821 | 81349 | RESISTOR,FXD,WW | | EA | 5 |
| 6 | 23 | | SMB438752 | 80063 | WASHER,LOCK | | EA | 9 |
| 6 | 24 | | 68M40 | 72962 | NUT,SLFLKG,HEX | | EA | 9 |
| 6 | 25 | | SMB508315 | 80063 | WASHER,INSULATION | | EA | 9 |
| 6 | 26 | | SMB508349 | 80063 | WASHER,FLAT | | EA | 9 |
| 6 | 27 | 5310-00-240-6445 | SMB504565 | 80063 | NUT,PLAIN,HEXAGON | | EA | 10 |
| 6 | 28 | 5310-00-543-2740 | MS35333-74 | 96906 | WASHER,LOCK | | EA | 10 |
| 6 | 29 | | SMD508365-3 | 80063 | CLAMP,LOOP | | EA | 3 |
| 6 | 30 | | 7622171003 | 13499 | DETECTOR SUBASSY | | EA | 1 |



EL5EL009

Figure 7. Test Set, Electronic Circuit Plug-In Unit AN/ARM-87, Detector Module, Blower Assembly.

| SECTION II | | TM11-6625-467-24P | | | | | | |
|--------------|------|-------------------|------------------|-------------|-------------|----------------------------|------|---|
| (1) | (2) | (3) | (4) | (5) | (6) | (7) | (8) | |
| ILLUSTRATION | | | | | | | | |
| (A) | (B) | NATIONAL | PART | | DESCRIPTION | USABLE ON CODE | U/M | |
| FIG | ITEM | STOCK | NUMBER | FSCM | | | | |
| NO | NO | NUMBER | NUMBER | | | | INC | |
| | | | | | | | IN | |
| | | | | | | | UNIT | |
| 7 | 1 | PAHZZ | 5905-00-682-4222 | RC07GF393K | 81349 | RESISTOR, FXD, CMPSN | EA | 1 |
| 7 | 2 | XDHZZ | | 7622196001 | 13499 | SPACER RF DETECTOR | EA | 2 |
| 7 | 3 | XDHZZ | | SMD508442-4 | 80063 | RESISTOR, VARIABLE | EA | 1 |
| 7 | 4 | PAHZZ | 5905-00-755-0795 | RC07GF392K | 81349 | RESISTOR, FXD, CMPSN | EA | 1 |
| 7 | 5 | XDHZZ | | SMC508413-2 | 80063 | CAPACITOR, FXD, CER | EA | 1 |
| 7 | 6 | XDHZZ | | 1N830A | 81349 | SEMICONDUCTOR, DIODE | EA | 1 |
| 7 | 7 | XDHZZ | | CC20CH040D | 81349 | CAPACITOR, FXD, CER SELECT | EA | 1 |
| 7 | 7 | PAHZZ | 5910-00-617-4948 | CC20CK010D | 81349 | CAPACITOR, FXD, CER SELECT | EA | 1 |
| 7 | 7 | PAHZZ | 5910-00-842-2292 | CC20CK020D | 81349 | CAPACITOR, FXD, CER SELECT | EA | 1 |
| 7 | 7 | PAHZZ | 5910-00-543-0822 | CC20CH050D | 81349 | CAPACITOR, FXD, CER SELECT | EA | 1 |
| 7 | 8 | PAHZZ | 5905-00-726-6441 | RC07GF561K | 81349 | RESISTOR, FXD, CMPSN | EA | 2 |
| 7 | 9 | XDHZZ | | SMC508498 | 80063 | PW BOARD | EA | 1 |
| 7 | 10 | PAHZZ | 5310-00-857-5547 | MS21044D06 | 96906 | NUT, PLAIN, HEXAGON | EA | 2 |
| 7 | 11 | XDHZZ | | 2N174 | 81349 | TRANSISTOR | EA | 2 |
| 7 | 12 | PAHZZ | 5961-00-893-9563 | 2N1016B | 81349 | TRANSISTOR | EA | 2 |
| 7 | 13 | XDHZZ | | SMC508364-3 | 80063 | WASHER, NONMETALLIC | EA | 2 |
| 7 | 14 | XDHZZ | | SMC508364-4 | 80063 | WASHER, FLAT | EA | 2 |
| 7 | 15 | XDHZZ | 5305-00-727-8832 | MS51959-29 | 96906 | SCREW, MACHINE | EA | 2 |
| 7 | 16 | XDHZZ | | SMD508307 | 80063 | HEAT SINK | EA | 2 |
| 7 | 17 | XDHZZ | | SMC508364-6 | 80063 | NUT, PLAIN, HEXAGON | EA | 2 |
| 7 | 18 | XDHZZ | | SMC508364-2 | 80063 | WASHER, NONMETALLIC | EA | 4 |
| 7 | 19 | XDHZZ | | SMC508364-5 | 80063 | TERMINAL, LUG | EA | 2 |
| 7 | 20 | XDHZZ | | SMC508364-1 | 80063 | INSULATOR PLATE | EA | 2 |

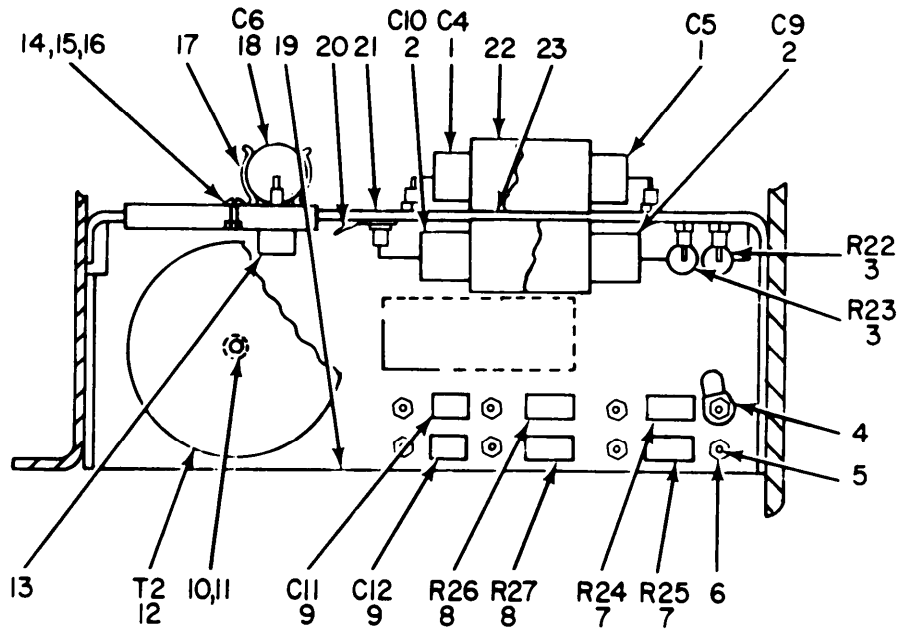
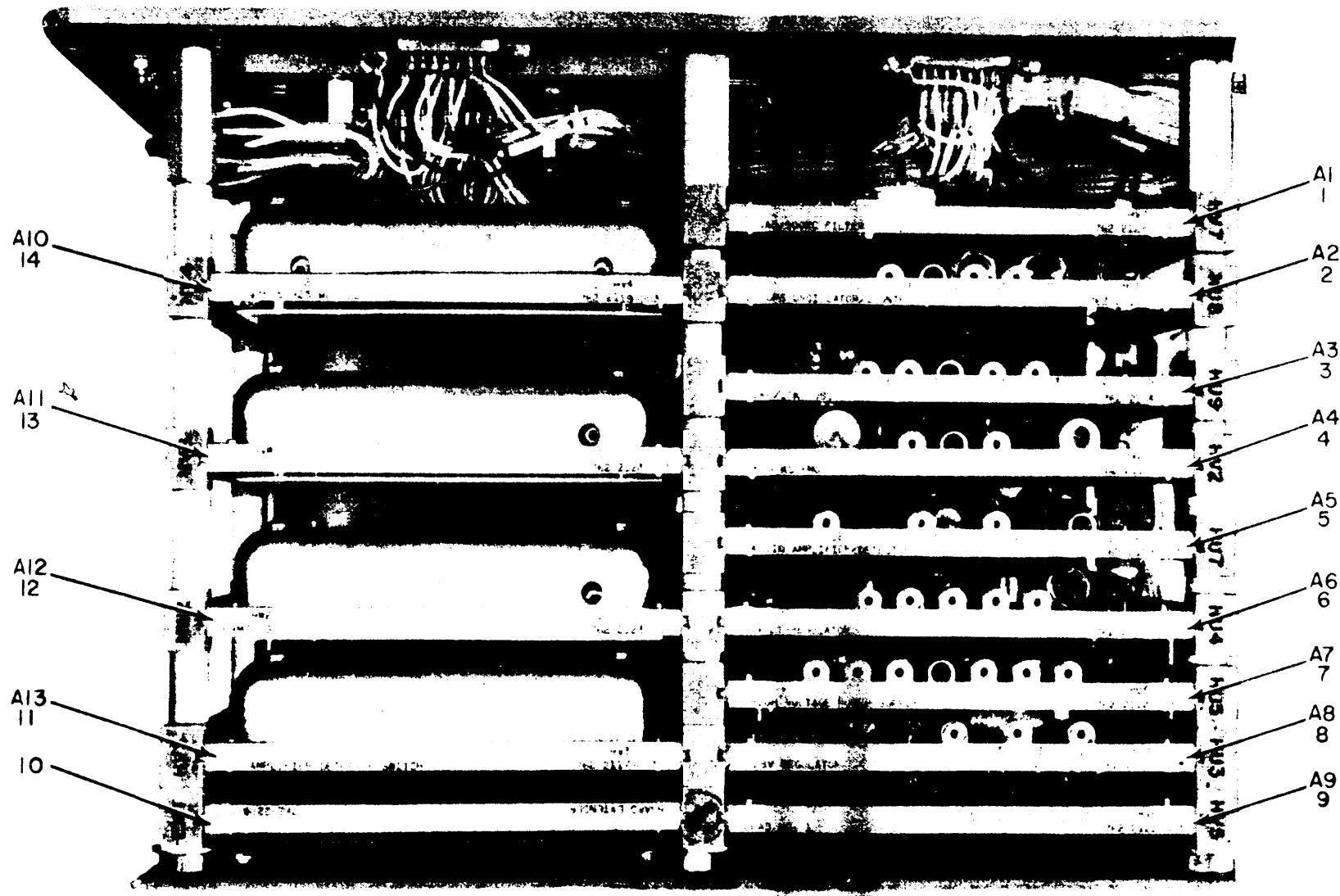

Figure 8. Test Set, Electronic Circuit Plug-In UniSAT AN/ARM-87, Transformer Bracket Assembly.

| SECTION II | | TM11-6625-467-24P | | | | | | |
|--------------|------|-------------------|------------------|--------------|-------------|-----------------------|------|----|
| (1) | (2) | (3) | (4) | (5) | (6) | (7) | (8) | |
| ILLUSTRATION | | | | | | | | |
| (A) | (B) | NATIONAL | PART | | DESCRIPTION | | QTY | |
| FIG | ITEM | STOCK | NUMBER | FSCM | | USABLE ON CODE | INC | |
| NO | NO | NUMBER | | | | | IN | |
| | | | | | | | UNIT | |
| 8 | 1 | XDHZZ | | CE13C120P | 81349 | CAPACITOR, FXD, ELCLT | EA | 2 |
| 8 | 2 | PAHZZ | 5910-00-079-9474 | CE13C221G | 81349 | CAPACITOR, FXD, ELCLT | EA | 2 |
| 8 | 3 | PAHZZ | 5905-00-914-8633 | RW67VR39 | 81349 | RESISTOR, FXD, WW | EA | 2 |
| 8 | 4 | XDHZZ | | SMB504539 | 80063 | TERMINAL, LUG | EA | 1 |
| 8 | 5 | XDHZZ | | SMC508363-2 | 80063 | TERMINAL, LUG | EA | 22 |
| 8 | 6 | PAHZZ | 5305-00-763-7822 | MS51959-14 | 96906 | SCREW, MACHINE | EA | 2 |
| 8 | 7 | PAHZZ | 5905-00-195-6814 | RC42GF102K | 81349 | RESISTOR, FXD, CMPSN | EA | 2 |
| 8 | 8 | PAHZZ | 5905-00-814-9680 | RW67V100 | 81349 | RESISTOR, FXD, WW | EA | 2 |
| 8 | 9 | PAHZZ | 5910-00-082-4926 | CS13BF685K | 81349 | CAPACITOR, FXD, ELCLT | EA | 2 |
| 8 | 10 | PAHZZ | 5305-00-059-3657 | MS51958-61 | 96906 | SCREW, MACHINE | EA | 1 |
| 8 | 11 | XDHZZ | | SMB508559 | 80063 | WASHER, LOCK | EA | 1 |
| 8 | 12 | XDHZZ | | SMD508322 | 80063 | TRANSFORMER, PWR, STU | EA | 1 |
| 8 | 13 | XDHZZ | | SMD504037-1 | 80063 | CLAMP, LOOP | EA | 2 |
| 8 | 14 | PAHZZ | 5305-00-054-6653 | MS51957-29 | 96906 | SCREW, MACHINE | EA | 2 |
| 8 | 15 | XDHZZ | | 310004600 | 79807 | WASHER, FLAT | EA | 1 |
| 8 | 16 | XDHZZ | | 68NM62 | 72962 | NUT, SLPLKG, HEX | EA | 1 |
| 8 | 17 | XDHZZ | | SMC508369 | 80063 | CLIP, ELECTRICAL | EA | 1 |
| 8 | 18 | XDHZZ | | SMD508441-3 | 80063 | CAPACITOR, FXD, ELCLT | EA | 1 |
| 8 | 19 | XDHZZ | | SMD508454 | 80063 | BRACKET, MOUNTING | EA | 1 |
| 8 | 20 | XDHZZ | | SMC508398-1 | 80063 | PLATE, MOUNTING | EA | 1 |
| 8 | 21 | XDHZZ | | SMC508463 | 80063 | BRACKET, MOUNTING | EA | 1 |
| 8 | 22 | XDHZZ | | SMD508367-1 | 80063 | CLIP, ELECTRICAL | EA | 4 |
| 8 | 23 | XDHZZ | 5320-00-117-6826 | MS20470AD4-4 | 96906 | RIVET, SOLID | EA | 6 |



EL5ELO11

Figure 9. Test Set, Electronic Circuit Plug-In Unit AN/ARM-87, Plug-In Modules.

| SECTION II | | TM11-6625-467-24P | | | | | | |
|--------------|------|-------------------|-------------------------------|-------|-------------------|----------------|------|--|
| (1) | (2) | (3) | (4) | (5) | (6) | (7) | (8) | |
| ILLUSTRATION | | | | | | | QTY | |
| (A) | (B) | NATIONAL | PART | FSCM | DESCRIPTION | USABLE ON CODE | INC | |
| FIG | ITEM | STOCK | NUMBER | | | | IN | |
| NO | NO | NUMBER | | | | | UNIT | |
| 9 | 1 | XDHHH | SMD508478 | 80063 | CIRCUIT CARD ASSY | | EA 1 | |
| 9 | 2 | XDHHH | SMD508461 | 80063 | CIRCUIT CARD ASSY | | EA 1 | |
| 9 | 3 | XDHHH | SMD508471 | 80063 | CIRCUIT CARD ASSY | | EA 1 | |
| 9 | 4 | XDHHH | SMD508468 | 80063 | CIRCUIT CARD ASSY | | EA 1 | |
| 9 | 5 | XDHHH | SMD508459 | 80063 | CIRCUIT CARD ASSY | | EA 1 | |
| 9 | 6 | XDHHH | SMD508480 | 80063 | CIRCUIT CARD ASSY | | EA 1 | |
| 9 | 7 | XDHHH | SMD508506 | 80063 | CIRCUIT CARD ASSY | | EA 1 | |
| 9 | 8 | XDHHH | SMD508483 | 80063 | CIRCUIT CARD ASSY | | EA 1 | |
| 9 | 9 | XDHHH | SMD508496 | 80063 | CIRCUIT CARD ASSY | | EA 1 | |
| 9 | 10 | PAHHZ | 6625-00-906-7958 SMD508502 | 80063 | CIRCUIT CARD ASSY | | EA 1 | |
| 9 | 11 | XDHHH | SMD508486 | 80063 | CIRCUIT CARD ASSY | | EA 1 | |
| 9 | 12 | XDHHH | SMD508493 | 80063 | CIRCUIT CARD ASSY | | EA 1 | |
| 9 | 13 | XDHHH | SMD508475 | 80063 | CIRCUIT CARD ASSY | | EA 1 | |
| 9 | 14 | XDHHH | SMD508490 | 80063 | CIRCUIT CARD ASSY | | EA 1 | |

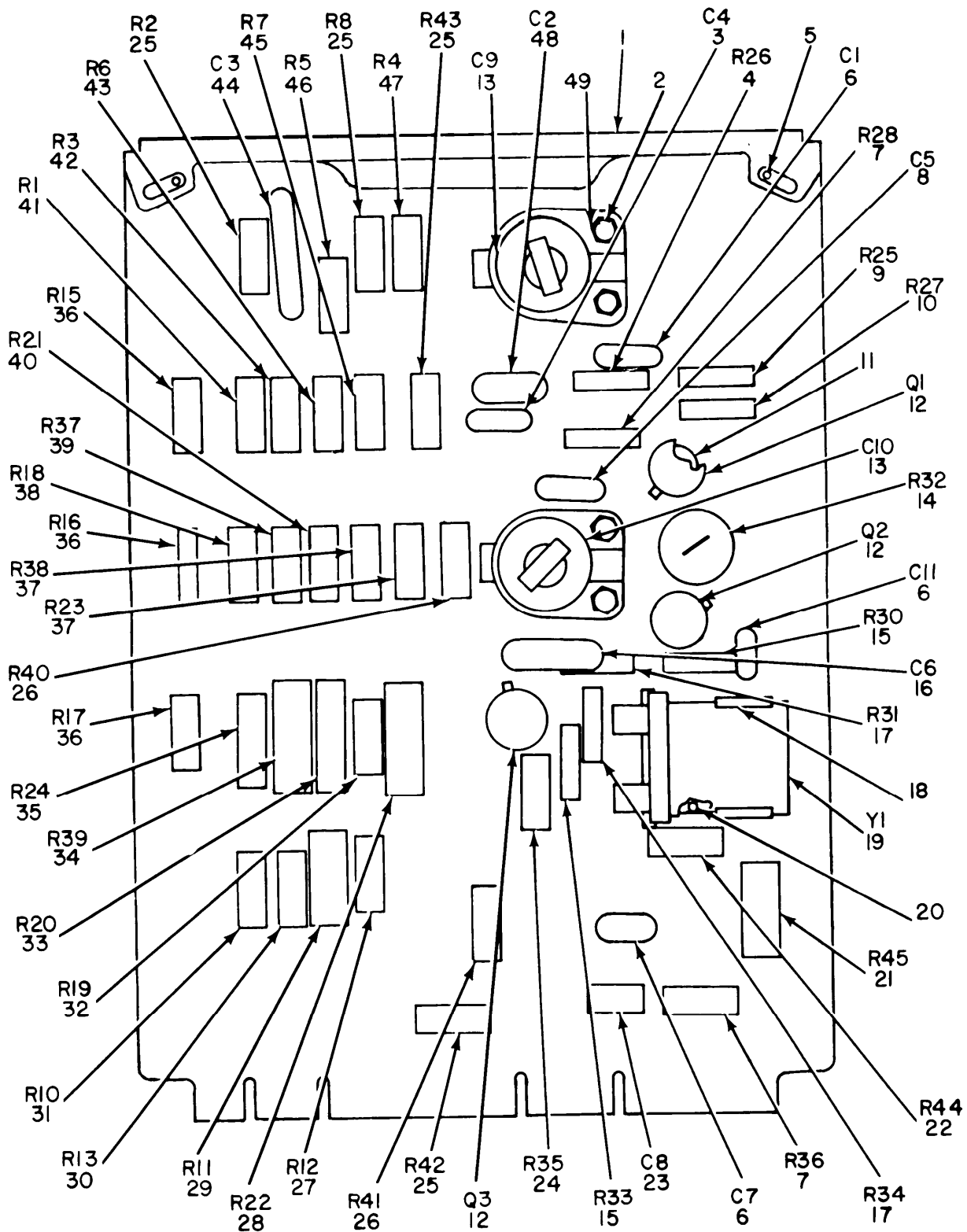

NOTE: FOR COMPLETE REFERENCE DESIGNATION
PREFIX WITH HV7A1

EL5E012

Figure 10. Test Set, Electronic Plug-In Unit AN/ARM-87, Load 500-KHz Filter Board.

| SECTION II | | TM11-6625-467-24P | | | | | | |
|--------------|------|-------------------|------------------|-------------|-------------|---------------------|------|---|
| (1) | (2) | (3) | (4) | (5) | (6) | (7) | (8) | |
| ILLUSTRATION | | | | | | | | |
| (A) | (B) | NATIONAL | PART | | DESCRIPTION | USABLE ON CODE | U/M | |
| FIG | ITEM | STOCK | NUMBER | FSCM | | | | |
| NO | NO | NUMBER | NUMBER | | | | INC | |
| | | | | | | | IN | |
| | | | | | | | UNIT | |
| 10 | 1 | XDHZZ | | SMD508399 | 80063 | HANDLE BOARD | EA | 1 |
| 10 | 2 | PAHZZ | 5305-00-054-5650 | MS51957-16 | 96906 | SCREW,MACHINE | EA | 4 |
| 10 | 3 | PAHZZ | 5910-00-811-5081 | CM05F121J03 | 81349 | CAPACITOR,FXD,MICA | EA | 1 |
| 10 | 4 | PAHZZ | 5905-00-682-4098 | RC07GF392J | 81349 | RESISTOR,FXD,CMPSN | EA | 1 |
| 10 | 5 | XDHZZ | | SMC508318 | 80063 | PIN SPRING | EA | 2 |
| 10 | 6 | XDHZZ | | SMC508413-2 | 80063 | CAPACITOR,FXD,CER | EA | 2 |
| 10 | 7 | PAHZZ | 5905-00-811-7912 | RC07GF47DR | 81349 | RESISTOR,FXD,CMPSN | EA | 2 |
| 10 | 8 | PAHZZ | 5910-00-954-1769 | CM05F151J03 | 81349 | CAPACITOR,FXD,MICA | EA | 1 |
| 10 | 9 | PAHZZ | 5905-00-752-3158 | RC07GF823K | 81349 | RESISTOR,FXD,CMPSN | EA | 1 |
| 10 | 10 | PAHZZ | 5905-00-686-4528 | RC07GF332K | 81349 | RESISTOR,FXD,CMPSN | EA | 1 |
| 10 | 11 | XDHZZ | | SMC508303 | 80063 | INSULATOR DISK | EA | 3 |
| 10 | 12 | XDHZZ | | SMD505017 | 80063 | TRANSISTOR | EA | 3 |
| 10 | 13 | PAHZZ | 5910-00-578-1623 | CV11C450 | 81349 | CAPACITOR,VAR,MICA | EA | 2 |
| 10 | 14 | XDHZZ | | SMD508442-2 | 80063 | RESISTOR,VARIABLE | EA | 1 |
| 10 | 15 | PAHZZ | 5905-00-688-4447 | RC07GF473K | 81349 | RESISTOR,FXD,CMPSN | EA | 2 |
| 10 | 16 | PAHZZ | 5910-00-060-1194 | CM06F102J03 | 81349 | CAPACITOR,FXD,MICA | EA | 1 |
| 10 | 17 | PAHZZ | 5905-00-726-6436 | RC07GF333K | 81349 | RESISTOR,FXD,CMPSN | EA | 2 |
| 10 | 18 | XDHZZ | | SMD508327 | 80063 | SOCKET,CRYSTAL | EA | 1 |
| 10 | 19 | PAHZZ | 5955-00-892-3393 | CR25AU | 81349 | CRYSTAL,UNIT,QUARTZ | EA | 1 |
| 10 | 20 | PAHZZ | 5320-00-721-5244 | MS16535-77 | 96906 | RIVET,SOLID | EA | 2 |
| 10 | 21 | PAHZZ | 5905-00-079-4057 | RN65D61R9F | 81349 | RESISTOR,FXD,FILM | EA | 1 |
| 10 | 22 | PAHZZ | 5905-00-964-2376 | RN65D1101F | 81349 | RESISTOR,FXD,FILM | EA | 1 |
| 10 | 23 | XDHZZ | | SMD508412-1 | 80063 | CAPACITOR,ELCTLT | EA | 1 |
| 10 | 24 | PAHZZ | 5905-00-171-2009 | RC20GF222K | 81349 | RESISTOR,FXD,CMPSN | EA | 1 |
| 10 | 25 | PAHZZ | 5905-00-894-6811 | RN65D51R1F | 81349 | RESISTOR,FXD,FILM | EA | 4 |
| 10 | 26 | PAHZZ | 5905-00-952-9435 | RN65D9092F | 81349 | RESISTOR,FXD,FILM | EA | 2 |
| 10 | 27 | PAHZZ | 5905-00-993-1358 | RN65D2371F | 81349 | RESISTOR,FXD,FILM | EA | 1 |
| 10 | 28 | PAHZZ | 5905-00-195-6814 | RC42GF102K | 81349 | RESISTOR,FXD,CMPSN | EA | 1 |
| 10 | 29 | PAHZZ | 5905-00-993-2264 | RN65D4020F | 81349 | RESISTOR,FXD,FILM | EA | 1 |
| 10 | 30 | PAHZZ | 5905-00-993-6012 | RN65D1471F | 81349 | RESISTOR,FXD,FILM | EA | 1 |
| 10 | 31 | PAHZZ | 5905-00-990-3029 | RN65D7502F | 81349 | RESISTOR,FXD,FILM | EA | 1 |
| 10 | 32 | PAHZZ | 5905-00-811-0673 | RC07GF682K | 81349 | RESISTOR,FXD,CMPSN | EA | 1 |
| 10 | 33 | XDHZZ | | RN70B7503F | 81349 | RESISTOR,FXD,FILM | EA | 1 |
| 10 | 34 | PAHZZ | 5905-00-552-5716 | RN70B2374F | 81349 | RESISTOR,FXD,CMPSN | EA | 1 |
| 10 | 35 | PAHZZ | 5905-00-001-7178 | RN65D623F | 81349 | RESISTOR,FXD,FILM | EA | 1 |
| 10 | 36 | PAHZZ | 5905-00-761-1901 | RN60D2151F | 81349 | RESISTOR,FXD,FILM | EA | 3 |
| 10 | 37 | PAHZZ | 5905-00-950-4378 | RN65D8253F | 81349 | RESISTOR,FXD,FILM | EA | 2 |
| 10 | 38 | PAHZZ | 5905-00-892-6466 | RN65D8252F | 81349 | RESISTOR,FXD,FILM | EA | 1 |
| 10 | 39 | PAHZZ | 5905-00-892-6475 | RN65D1004F | 81349 | RESISTOR,FXD,FILM | EA | 1 |
| 10 | 40 | PAHZZ | 5905-00-989-5574 | RN65D1623F | 81349 | RESISTOR,FXD,FILM | EA | 1 |

| SECTION II | | TM11-6625-467-24P | | | | | | |
|--------------|------|-------------------|------------------|-------------|-------------|----------------------|------|---|
| (1) | (2) | (3) | (4) | (5) | (6) | (7) | (8) | |
| ILLUSTRATION | | | | | | | QTY | |
| (A) | (B) | NATIONAL | | | DESCRIPTION | | INC | |
| FIG | ITEM | STOCK | PART | FSCM | | USABLE ON CODE | IN | |
| NO | NO | NUMBER | NUMBER | | | | UNIT | |
| | | | | | | | | |
| 10 | 41 | PAHZZ | 5905-00-892-7278 | RN65D3011F | 81349 | RESISTOR, FXD, FILM | EA | 1 |
| 10 | 42 | PAHZZ | 5905-00-060-2484 | RN65D2612F | 81349 | RESISTOR, FXD, FILM | EA | 1 |
| 10 | 43 | PAHZZ | 5905-00-088-2298 | RN65D1470F | 81349 | RESISTOR, FXD, FILM | EA | 1 |
| 10 | 44 | XDHZZ | | SMD508417 | 80063 | CAPACITOR, FXD, CER | EA | 1 |
| 10 | 45 | XDHZZ | 5905-00-950-6793 | RN65D9311F | 81349 | RESISTOR, FXD, FILM | EA | 1 |
| 10 | 46 | PAHZZ | 5905-00-721-0552 | RC07GF105K | 81349 | RESISTOR, FXD, CMPSN | EA | 1 |
| 10 | 47 | PAHZZ | 5905-00-964-2219 | RN65D5621F | 81349 | RESISTOR, FXD, FILM | EA | 1 |
| 10 | 48 | PAHZZ | 5910-00-088-0283 | CM05E390J03 | 81349 | CAPACITOR, FXD, CER | EA | 1 |
| 10 | 49 | PAHZZ | 5310-00-857-5548 | MS21044D04 | 96906 | NUT, PLAIN, HEXAGON | EA | 4 |

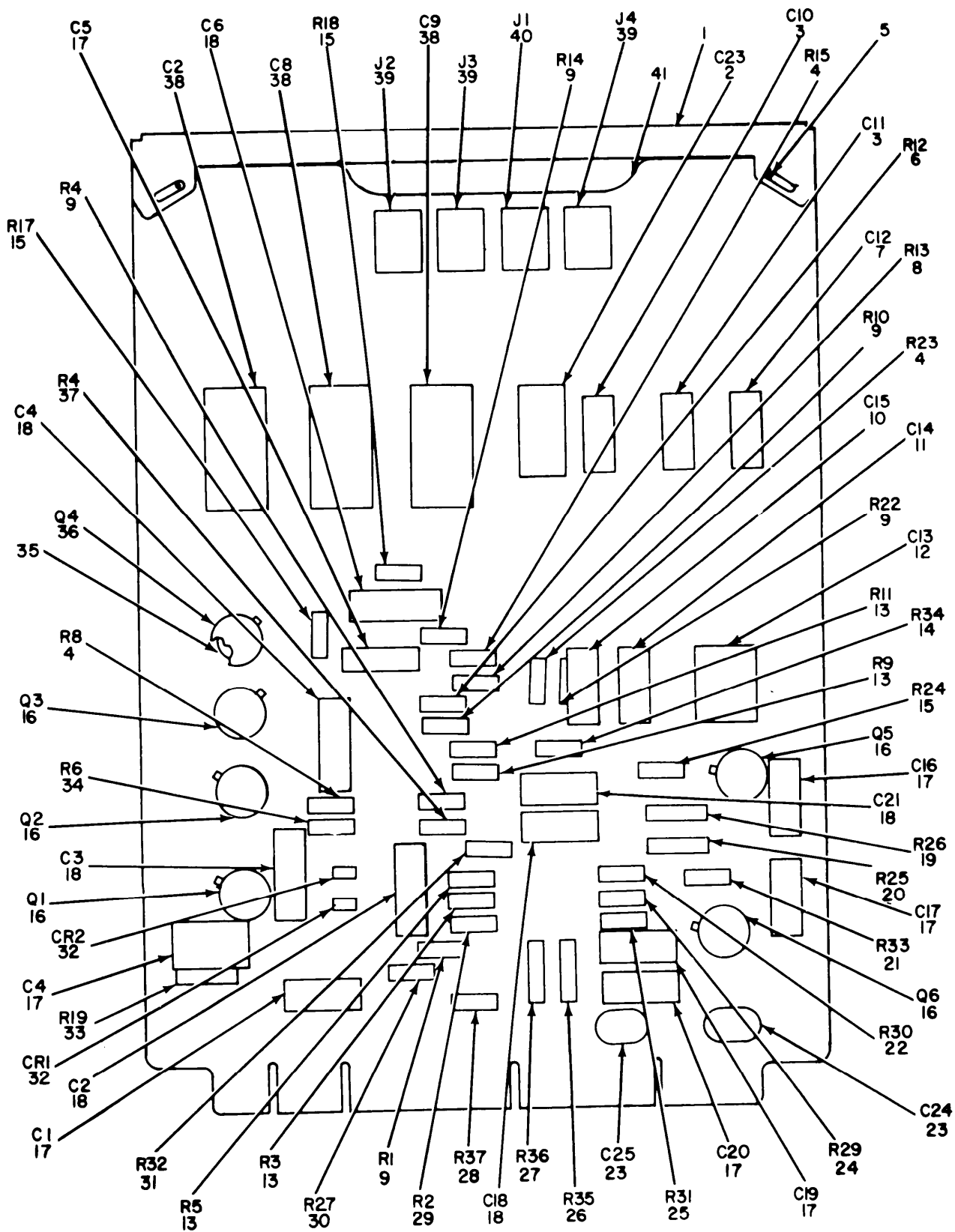

NOTE: FOR COMPLETE REFERENCE DESIGNATION
PREFIX WITH HUBA2

EL5ELOI3

Figure 11. Test Set, Electronic Circuit Plug-In Unit AN/ARM-87,
150 cps Oscillator-Counter Board.

| SECTION II | | TM11-6625-467-24P | | | | | | |
|--------------|------|-------------------|----------------|-------|-----------------------|----------------|-----------------|--|
| (1) | (2) | (3) | (4) | (5) | (6) | (7) | (8) | |
| ILLUSTRATION | | | | | DESCRIPTION | USABLE ON CODE | QTY INC IN UNIT | |
| (A) | (B) | NATIONAL | PART | FSCM | | U/M | | |
| FIG | ITEM | STOCK | NUMBER | | | | | |
| NO | NO | NUMBER | NUMBER | | | | | |
| 11 | 1 | | SMD508399 | 80063 | HANDLE, BOARD | EA | 1 | |
| 11 | 2 | | SMD508433-1 | 80063 | CAPACITOR, FXD, PAPER | EA | 1 | |
| 11 | 3 | | SMD508433-2 | 80063 | CAPACITOR, FXD, PAPER | EA | 2 | |
| 11 | 4 | 5905-00-119-3504 | RC07GF273J | 81349 | RESISTOR, FXD, CMPSN | EA | 3 | |
| 11 | 5 | | SMC508318 | 80063 | PIN, STRAIGHT, HOLDS | EA | 2 | |
| 11 | 6 | 5905-00-811-0673 | RC07GF682K | 81349 | RESISTOR, FXD, CMPSN | EA | 1 | |
| 11 | 7 | | SMD504123-3 | 80063 | CAPACITOR, FXD, PAPER | EA | 1 | |
| 11 | 8 | 5905-00-726-6441 | RC07GF561K | 81349 | RESISTOR, FXD, CMPSN | EA | 1 | |
| 11 | 9 | 5905-00-688-4447 | RC07GF473K | 81349 | RESISTOR, FXD, CMPSN | EA | 5 | |
| 11 | 10 | 5910-00-957-8582 | CM06F222J03 | 81349 | CAPACITOR, FXD, MICA | EA | 1 | |
| 11 | 11 | | CM06F332J03 | 81349 | CAPACITOR, FXD, MICA | EA | 1 | |
| 11 | 12 | | CM07F103J03 | 81349 | CAPACITOR, FXD, MICA | EA | 1 | |
| 11 | 13 | 5905-00-686-4527 | RC07GF272K | 81349 | RESISTOR, FXD, CMPSN | EA | 4 | |
| 11 | 14 | 5905-00-110-7620 | RCR07G102JS | 81349 | RESISTOR, FXD, CMPSN | EA | 1 | |
| 11 | 15 | 5905-00-106-1356 | RC07GF152K | 81349 | RESISTOR, FIXED, COMP | EA | 3 | |
| 11 | 16 | | SMD505017 | 80063 | TRANSISTOR | EA | 5 | |
| 11 | 17 | | SMD508415 | 80063 | CAPACITOR, FXD, CER | EA | 7 | |
| 11 | 18 | | SMD508412-4 | 80063 | CAPACITOR, ELCTLT | EA | 6 | |
| 11 | 19 | 5905-00-894-6811 | RN65D51R1F | 81349 | RESISTOR, FXD, FILM | EA | 1 | |
| 11 | 20 | 5905-00-813-8640 | RN65D5111F | 81349 | RESISTOR, FXD, FILM | EA | 1 | |
| 11 | 21 | 5905-00-683-7721 | RC07GF101J | 81349 | RESISTOR, FXD, CMPSN | EA | 1 | |
| 11 | 22 | 5905-00-686-4529 | RC07GF123K | 81349 | RESISTOR, FXD, CMPSN | EA | 1 | |
| 11 | 23 | | 805014X5V0103Z | 72982 | CAPACITOR, FXD, CER | EA | 2 | |
| 11 | 24 | 5905-00-726-5345 | RC07GF154K | 81349 | RESISTOR, FXD, CMPSN | EA | 1 | |
| 11 | 25 | 5905-00-115-3560 | RC07GF183K | 81349 | RESISTOR, FXD, CMPSN | EA | 1 | |
| 11 | 26 | 5905-00-951-5713 | RN65D1962F | 81349 | RESISTOR, FXD, FILM | EA | 1 | |
| 11 | 27 | 5905-00-989-5580 | RN65D5110F | 81349 | RESISTOR, FXD, FILM | EA | 1 | |
| 11 | 28 | 5905-00-816-8554 | RC07GF103K | 81349 | RESISTOR, FXD, CMPSN | EA | 1 | |
| 11 | 29 | 5905-00-726-6436 | RC07GF333K | 81349 | RESISTOR, FXD, CMPSN | EA | 1 | |
| 11 | 30 | 5905-00-726-5344 | RC07GF153K | 81349 | RESISTOR, FXD, CMPSN | EA | 1 | |
| 11 | 31 | 5905-00-825-2360 | RC07GF221K | 81349 | RESISTOR, FXD, CMPSN | EA | 1 | |
| 11 | 32 | | SMD508555-2 | 80063 | SEMICONDUCTOR, DIODE | EA | 2 | |
| 11 | 33 | 5905-00-726-6431 | RC07GF184K | 81349 | RESISTOR, FXD, CMPSN | EA | 1 | |
| 11 | 34 | 5905-00-726-5346 | RC07GF182K | 81349 | RESISTOR, FXD, CMPSN | EA | 1 | |
| 11 | 35 | | SMC508303 | 80063 | INSULATOR, DISK | EA | 6 | |
| 11 | 36 | 5961-00-949-1432 | 2N2219 | 81349 | TRANSISTOR | EA | 1 | |
| 11 | 37 | | RC07GF124K | 81349 | RESISTOR, FXD, CMPSN | EA | 1 | |
| 11 | 38 | | SMD508123-4 | 80063 | CAPACITOR, FXD, PAPER | EA | 3 | |
| 11 | 39 | | SMD508370-1 | 80063 | JACK, TIP | EA | 3 | |
| 11 | 40 | | SMD508370-3 | 80063 | JACK, TIP | EA | 1 | |

| SECTION II | | TM11-6625-467-24P | | | | | | |
|--------------|------|-------------------|-----------|-------------|----------------|-----|------|---|
| (1) | (2) | (3) | (4) | (5) | (6) | (7) | (8) | |
| ILLUSTRATION | | | | | | | QTY | |
| (A) | (B) | NATIONAL | PART | DESCRIPTION | | | INC | |
| FIG | ITEM | STOCK | NUMBER | FSCM | USABLE ON CODE | U/M | IN | |
| NO | NO | CODE | NUMBER | | | | UNIT | |
| 11 | 41 | XDHZZ | SMD508457 | 80063 | PW, BOARD | | EA | 1 |

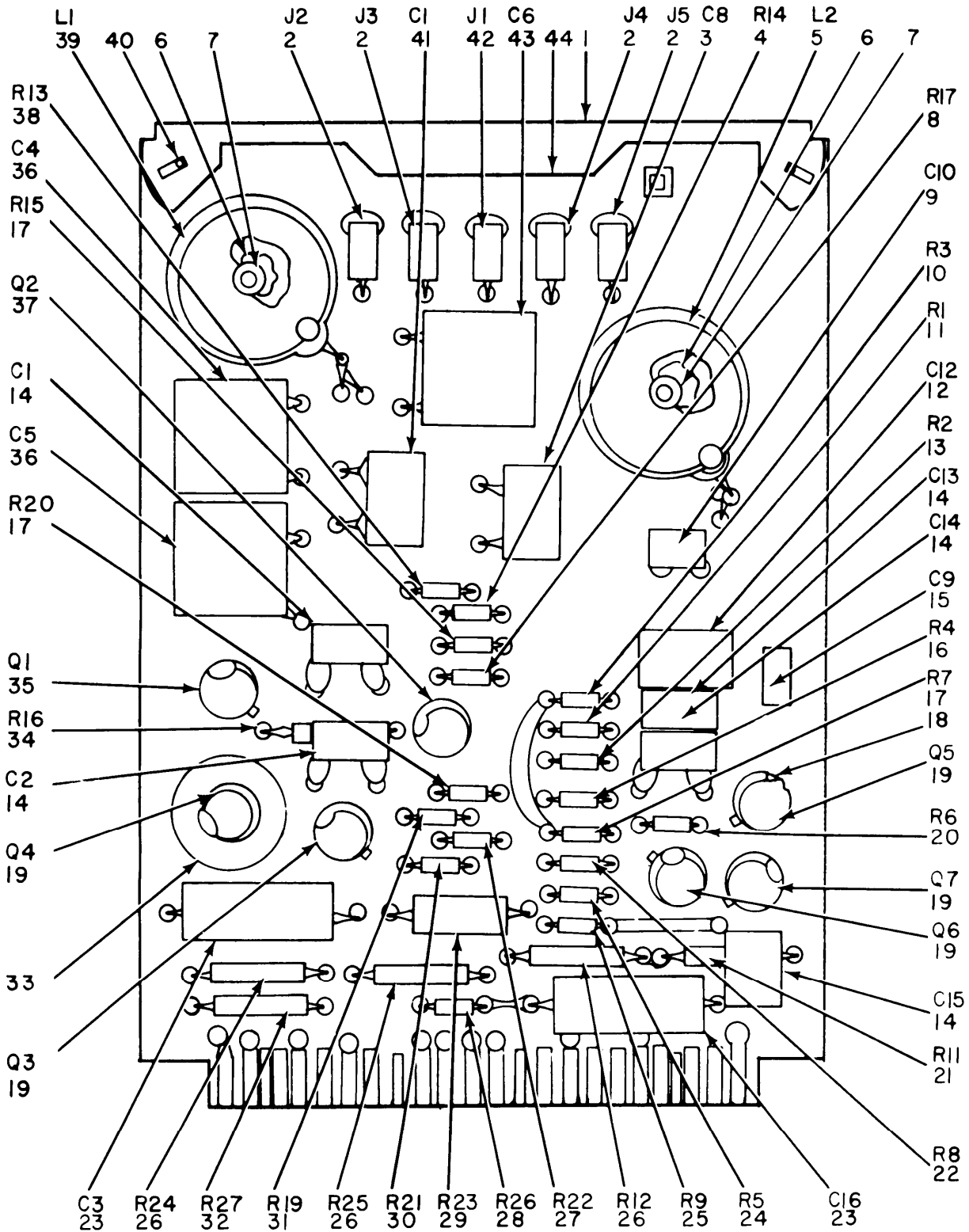

NOTE: FOR COMPLETE REFERENCE DESIGNATION
PREFIX WITH HU9A3.

EL5ELO14

Figure 12, Test Set, Electronic Circuit Plug-In Unit AN/ARM-87,
1-KHz/10-KHz Oscillator.

| SECTION II | | TM11-6625-467-24P | | | | | | |
|--------------|------|-------------------|-------------|-------|-----------------------|----------------|-----------------|--|
| (1) | (2) | (3) | (4) | (5) | (6) | (7) | (8) | |
| ILLUSTRATION | | | | | DESCRIPTION | USABLE ON CODE | QTY INC IN UNIT | |
| (A) | (B) | NATIONAL | PART | FSCM | | U/M | | |
| FIG | ITEM | STOCK | NUMBER | | | | | |
| NO | NO | NUMBER | | | | | | |
| 12 | 1 | | SMD508399 | 80063 | HANDLE, BOARD | EA | 1 | |
| 12 | 2 | | SMD508370-1 | 80063 | JACK, TIP | EA | 4 | |
| 12 | 3 | 5910-00-880-6080 | CM06F122J03 | 81349 | CAPACITOR, FXD, MICA | EA | 1 | |
| 12 | 4 | 5905-00-816-8554 | RC07GF103K | 81349 | RESISTOR, FXD, CMPSN | EA | 1 | |
| 12 | 5 | | SMD508353-1 | 80063 | COIL, RADIO, FREQ | EA | 1 | |
| 12 | 6 | | SMC508320-2 | 80063 | WASHER, FLAT | EA | 2 | |
| 12 | 7 | 5305-00-054-6651 | MS51957-27 | 96906 | SCREW, MACHINE | EA | 2 | |
| 12 | 8 | 5905-00-752-3157 | RC07GF273K | 81349 | RESISTOR, FXD, CMPSN | EA | 1 | |
| 12 | 9 | 5910-00-088-0282 | CM05F181J03 | 81349 | CAPACITOR, FXD, MICA | EA | 1 | |
| 12 | 10 | 5905-00-686-4525 | RC07GF271K | 81349 | RESISTOR, FXD, CMPSN | EA | 1 | |
| 12 | 11 | 5905-00-925-7172 | RC07GF102J | 81349 | RESISTOR, FIXED, COMP | EA | 1 | |
| 12 | 12 | 5910-00-717-5853 | CM06F182J03 | 81349 | CAPACITOR, FXD, MICA | EA | 1 | |
| 12 | 13 | 5905-00-726-3807 | RC07GF912J | 81349 | RESISTOR, FXD, CMPSN | EA | 1 | |
| 12 | 14 | | SMD508415 | 80063 | CAPACITOR, FXD, CER | EA | 5 | |
| 12 | 15 | | SMD508412-2 | 80063 | CAPACITOR, ELCTLT | EA | 1 | |
| 12 | 16 | 5905-00-686-4527 | RC07GF272K | 81349 | RESISTOR, FXD, CMPSN | EA | 1 | |
| 12 | 17 | 5905-00-686-9997 | RC07GF682J | 81349 | RESISTOR, FXD, CMPSN | EA | 3 | |
| 12 | 18 | | SMC500303 | 80063 | INSULATOR, DISK | EA | 7 | |
| 12 | 19 | | SMD505017 | 80063 | TRANSISTOR | EA | 5 | |
| 12 | 20 | 5905-00-110-7620 | RCR07G102JS | 81349 | RESISTOR, FXD, CMPSN | EA | 1 | |
| 12 | 21 | 5905-00-969-5857 | RN65D4021F | 81349 | RESISTOR, FXD, FILM | EA | 1 | |
| 12 | 22 | 5905-00-752-3340 | RC07GF472K | 81349 | RESISTOR, FXD, CMPSN | EA | 1 | |
| 12 | 23 | 5910-00-905-2962 | CS138F476M | 81349 | CAPACITOR, ELCTLT | EA | 2 | |
| 12 | 24 | | RC07GF185K | 81349 | RESISTOR, FXD, CMPSN | EA | 1 | |
| 12 | 25 | 5905-00-106-1356 | RC07GF152K | 81349 | RESISTOR, FXD, CMPSN | EA | 1 | |
| 12 | 26 | 5905-00-958-3498 | RN65D51R1F | 81349 | RESISTOR, FXD, FILM | EA | 3 | |
| 12 | 27 | 5905-00-110-8768 | RCR07G821JS | 81349 | RESISTOR, FXD, CMPSN | EA | 1 | |
| 12 | 28 | 5905-00-683-7721 | RC07GF101J | 81349 | RESISTOR, FXD, CMPSN | EA | 1 | |
| 12 | 29 | 5905-00-279-2607 | RC32GF681K | 81349 | RESISTOR, FXD, CMPSN | EA | 1 | |
| 12 | 30 | 5905-00-755-0795 | RC07GF392K | 81349 | RESISTOR, FXD, CMPSN | EA | 1 | |
| 12 | 31 | 5905-00-825-2357 | RC07GF563K | 81349 | RESISTOR, FXD, CMPSN | EA | 1 | |
| 12 | 32 | 5905-00-952-4716 | RN65D1541F | 81349 | RESISTOR, FXD, FILM | EA | 1 | |
| 12 | 33 | | SMC508309 | 80063 | HEAT SINK | EA | 1 | |
| 12 | 34 | 5905-00-984-7684 | RN60D3322F | 81349 | RESISTOR, FXD, FILM | EA | 1 | |
| 12 | 35 | 5961-00-949-1432 | 2N2219 | 81349 | TRANSISTOR | EA | 1 | |
| 12 | 36 | | CM07F203J03 | 81349 | CAPACITOR, FXD, MICA | EA | 2 | |
| 12 | 37 | 5961-00-686-8578 | 2N338 | 81349 | TRANSISTOR | EA | 1 | |
| 12 | 38 | 5905-00-135-6046 | RC07GF681K | 81349 | RESISTOR, FIXED, COMP | EA | 1 | |
| 12 | 39 | | SMD508353-2 | 80063 | COIL, RADIO, FREQ | EA | 1 | |
| 12 | 40 | | SMC508318 | 80063 | PIN, STRAIGHT, HDLS | EA | 2 | |

| SECTION II | | TM11-6625-467-24P | | | | | | | |
|--------------|------|-------------------|------------------|-------------|-------------|----------------|-----|------|--|
| (1) | (2) | (3) | (4) | (5) | (6) | | (7) | (8) | |
| ILLUSTRATION | | | | | | | | | |
| (A) | (B) | | NATIONAL | | DESCRIPTION | | | QTY | |
| FIG | ITEM | SMR | STOCK | PART | | USABLE ON CODE | U/M | INC | |
| NO | NO | CODE | NUMBER | NUMBER | FSCM | | | IN | |
| | | | | | | | | UNIT | |
| 12 | 41 | PAHZZ | 5910-00-957-8582 | CM06F222J03 | 81349 | | EA | 1 | |
| 12 | 42 | XDHZZ | | SMD508370-3 | 80063 | | EA | 1 | |
| 12 | 43 | PAHZZ | 5910-00-883-9671 | CM07F822J03 | 81349 | | EA | 1 | |
| 12 | 44 | XDHZZ | | SMD508465 | 80063 | | EA | 1 | |

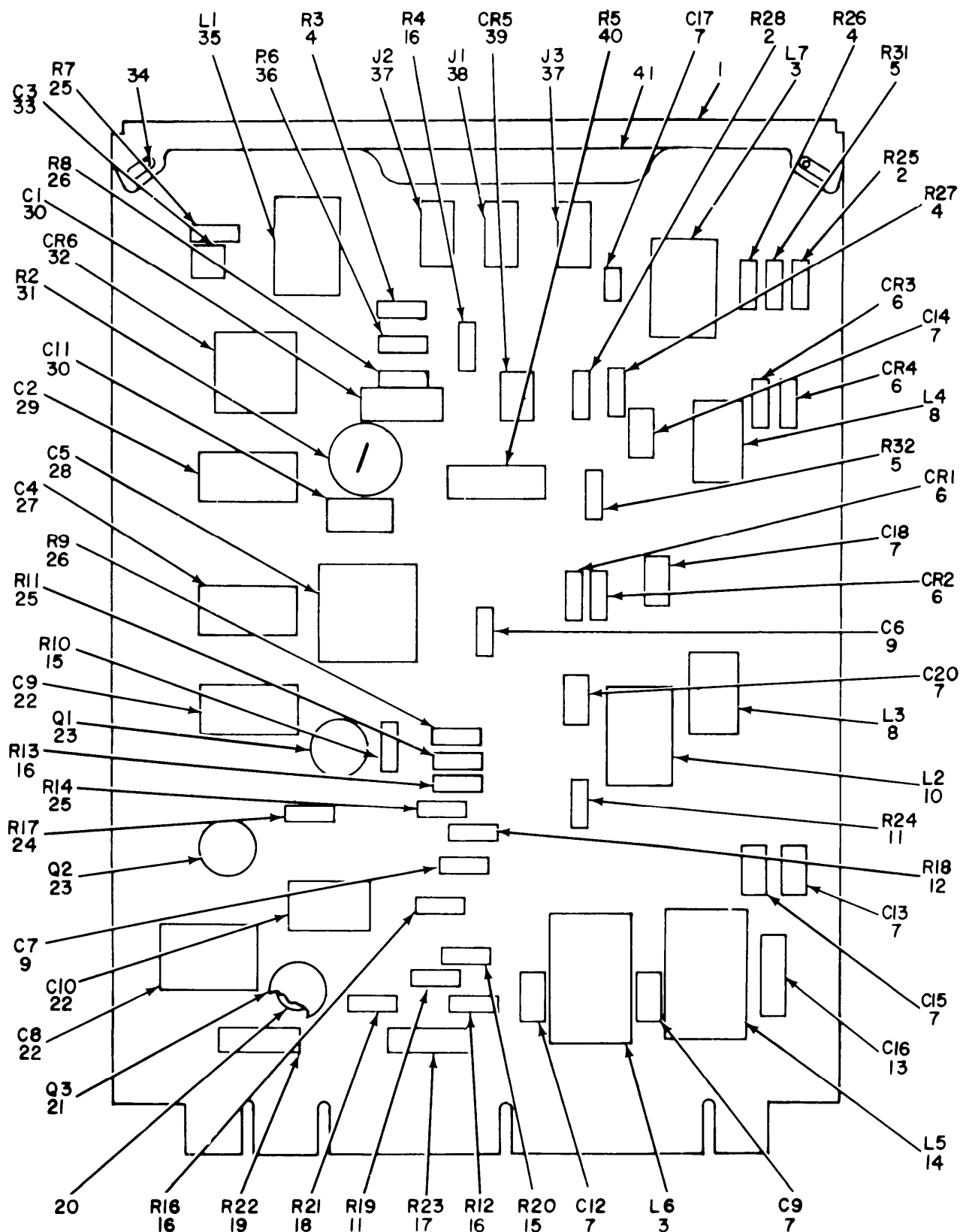

EL5ELO15

Figure 13. Test Set, Electronic Circuit Plug-In Unit AN/ARM-87, 500-KHz FM Oscillator.

| SECTION II (1) ILLUSTRATION | | (2) | (3) | (4) | (5) | TM11-6625-467-24P (6) | (7) | (8) |
|-----------------------------------|-------------------|-------------|-----------------------------|----------------|-------|--------------------------|----------------|--------------------------|
| (A) FIG NO | (B) ITEM NO | SMR CODE | NATIONAL STOCK NUMBER | PART NUMBER | FSCM | DESCRIPTION | USABLE ON CODE | U/M INC IN UNIT |
| 13 | 1 | XDHZZ | | SMD508399 | 80063 | HANDLE, BOARD | EA | 1 |
| 13 | 2 | PAHZZ | 5905-00-752-3157 | RC07GF273K | 81349 | RESISTOR, FXD, CMPSN | EA | 2 |
| 13 | 3 | XDHZZ | | SMC508340-3 | 80063 | CHOKE, RADIO, FREQ | EA | 2 |
| 13 | 4 | PAHZZ | 5905-00-686-4528 | RC07GF332K | 81349 | RESISTOR, FXD, CMPSN | EA | 3 |
| 13 | 5 | PAHZZ | 5905-00-688-4447 | RC07GF473K | 81349 | RESISTOR, FXD, CMPSN | EA | 2 |
| 13 | 6 | PAHZZ | 5961-00-615-0095 | 1N276 | 81349 | SEMICONDUCTOR, DIODE | EA | 4 |
| 13 | 7 | XDHZZ | | SMC508413-2 | 80063 | CAPACITOR, FXD, CER | EA | 8 |
| 13 | 8 | PAHZZ | 5950-00-892-8329 | MS75053-2 | 96906 | CHOKE, RADIO, FREQ | EA | 2 |
| 13 | 9 | PAHZZ | 5910-00-495-0042 | CS13G105KL | 81349 | CAPACITOR, FIXED, ELE | EA | 2 |
| 13 | 10 | PAHZZ | 5950-00-771-2089 | MS75054-5 | 96906 | CHOKE, RADIO, FREQ | EA | 1 |
| 13 | 11 | PAHZZ | 5905-00-686-4527 | RC07GF272K | 81349 | RESISTOR, FIXED, COMP | EA | 2 |
| 13 | 12 | PAHZZ | 5905-00-110-7620 | RCR07G102JS | 81349 | RESISTOR, FXD, CMPSN | EA | 1 |
| 13 | 13 | PAHZZ | 5910-00-043-2933 | CM06F821J03 | 81349 | CAPACITOR, FXD, MICA | EA | 1 |
| 13 | 14 | PAHZZ | 5950-00-089-3021 | SMC504617 | 80063 | CHOKE, RADIO, FREQ | EA | 1 |
| 13 | 15 | PAHZZ | 5905-00-726-5344 | RC07GF153K | 81349 | RESISTOR, FXD, CMPSN | EA | 2 |
| 13 | 16 | PAHZZ | 5905-00-755-0795 | RC07GF392K | 81349 | RESISOR, FXD, CMPSN | EA | 4 |
| 13 | 17 | PAHZZ | 5905-00-958-3498 | RN65D51R1F | 81349 | RESISTOR, FXD, FILM | EA | 1 |
| 13 | 18 | PAHZZ | 5905-00-726-6433 | RC07GF222K | 81349 | RESISTOR, FIXED, COMP | EA | 1 |
| 13 | 19 | XDHZZ | 5905-00-989-5580 | RN65D5110F | 81349 | RESISTOR, FXD, FILM | EA | 1 |
| 13 | 20 | XDHZZ | | SMC508303 | 80063 | INSULATOR, DISK | EA | 3 |
| 13 | 21 | XDHZZ | | SMD505017 | 80063 | TRANSISTOR | EA | 1 |
| 13 | 22 | XDHZZ | | CM06F332J03 | 81349 | CAPACITOR, FXD, MICA | EA | 3 |
| 13 | 23 | PAHZZ | 5961-00-949-1432 | 2N2219 | 81349 | TRANSISTOR | EA | 2 |
| 13 | 24 | PAHZZ | 5905-00-119-3503 | RC07GF271J | 81349 | RESISTOR, FXD, CMPSN | EA | 1 |
| 13 | 25 | PAHZZ | 5905-00-190-8879 | RC07GF183K | 81349 | RESISTOR, FXD, CMPSN | EA | 3 |
| 13 | 26 | PAHZZ | 5905-00-816-8554 | RC07GF103K | 81349 | RESISTOR, FXD, CMPSN | EA | 2 |
| 13 | 27 | PAHZZ | 5910-00-957-8582 | CM06F222J03 | 81349 | CAPACITOR, FXD, MICA | EA | 1 |
| 13 | 28 | XDHZZ | | CM07F622J03 | 81349 | CAPACITOR, FXD, MICA | EA | 1 |
| 13 | 29 | PAHZZ | 5910-00-717-5853 | CM06F182J03 | 81349 | CAPACITOR, FXD, MICA | EA | 1 |
| 13 | 30 | XDHZZ | | SMD508415 | 80063 | CAPACITOR, FXD, CER | EA | 2 |
| 13 | 31 | PAHZZ | 5905-00-856-7774 | SMD508442-3 | 80063 | RESISTOR, VARIABLE, W | EA | 1 |
| 13 | 32 | PAHZZ | 5961-00-728-5965 | SMC504585 | 80063 | SEMICONDUCTOR, DIODE | EA | 1 |
| 13 | 33 | XDHZZ | | SMD504272-4 | 80063 | CAPACITOR, FXD, CER | EA | 1 |
| 13 | 34 | XDHZZ | | SMC508318 | 80063 | PIN, STRAIGHT, HDLS | EA | 2 |
| 13 | 35 | PAHZZ | 5950-00-075-9144 | MS90538-12 | 96906 | CHOKE, RADIO, FREQ | EA | 1 |
| 12 | 36 | PAHZZ | 5905-00-686-4530 | RC07GF104K | 81349 | RESISTOR, FXD, CMPSN | EA | 1 |
| 12 | 37 | XDHZZ | | SMD508370-1 | 80063 | JACK, TIP | EA | 2 |
| 13 | 38 | XDHZZ | | SMD508370-3 | 80063 | JACK, TIP | EA | 1 |
| 13 | 39 | PAHZZ | 5961-00-579-4965 | 1N3020B | 81349 | SEMICONDUCTOR, DIODE | EA | 1 |
| 13 | 40 | PAHZZ | 5905-00-279-1722 | RC32GF102K | 81349 | RESISTOR, FXD, CMPSN | EA | 1 |

| SECTION II | | TM11-6625-467-24P | | | | | | |
|--------------|------|-------------------|-----------|-------------|----------------|-----|------|---|
| (1) | (2) | (3) | (4) | (5) | (6) | (7) | (8) | |
| ILLUSTRATION | | | | | | | QTY | |
| (A) | (B) | NATIONAL | PART | DESCRIPTION | | | INC | |
| FIG | ITEM | STOCK | NUMBER | FSCM | USABLE ON CODE | U/M | IN | |
| NO | NO | CODE | NUMBER | | | | UNIT | |
| 13 | 41 | XDHZZ | SMD508469 | 80063 | PW, BOARD | | EA | 1 |

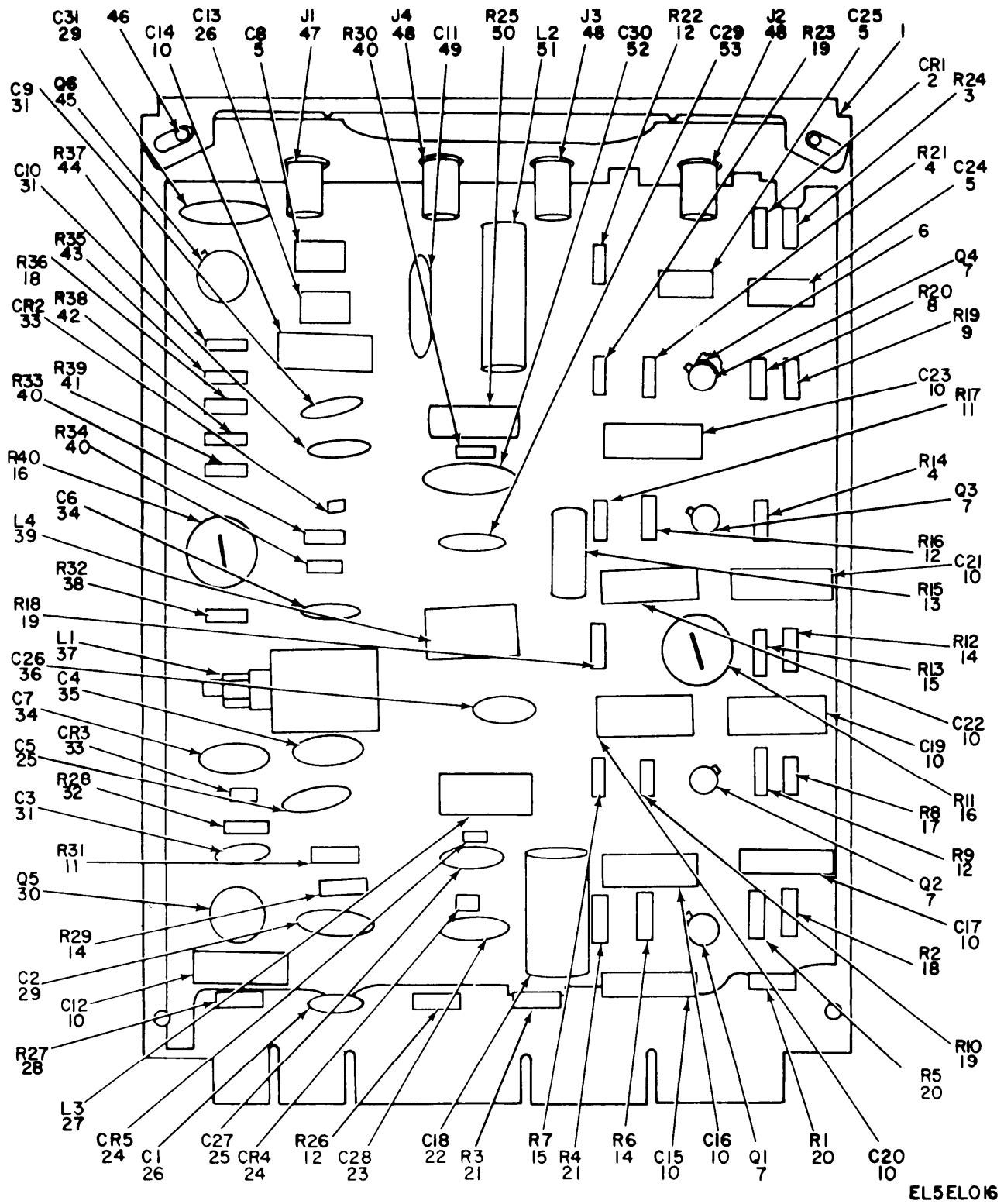
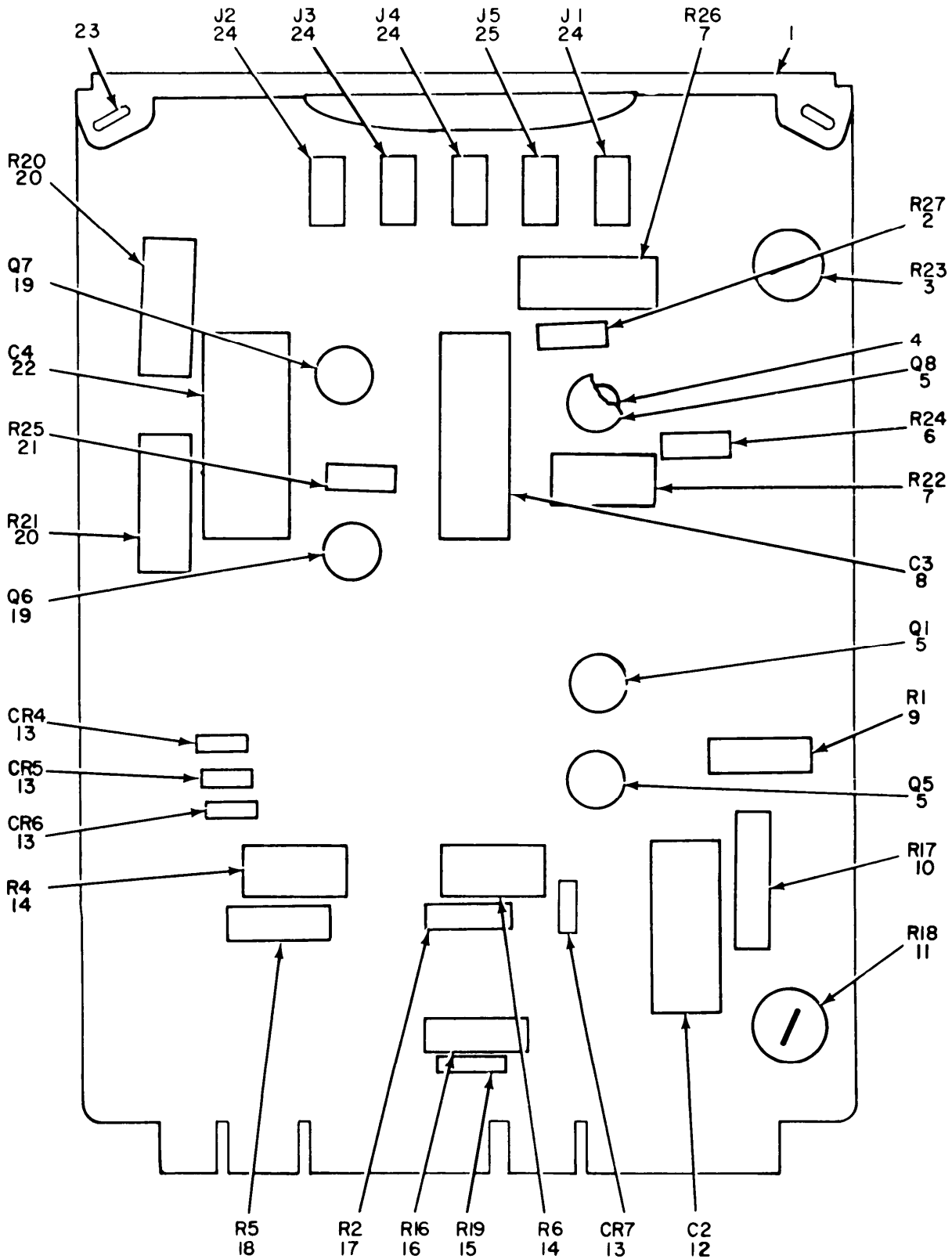

Figure 14. Test Set, Electronic circuit Plug-In Unit AN/ARM-87, Amplifier Detector Audio Board.

| SECTION II | | TM11-6625-467-24P | | | | | | |
|--------------|---------|-------------------|------------------|-------------|----------------------|------------------------|-----------------|--|
| (1) | (2) | (3) | (4) | (5) | (6) | (7) | (8) | |
| ILLUSTRATION | | | | | DESCRIPTION | USABLE ON CODE | QTY INC IN UNIT | |
| (A) | (B) | NATIONAL | PART | FSCM | | U/M | | |
| FIG NO | ITEM NO | STOCK NUMBER | NUMBER | | | | | |
| 14 | 1 | XDHZZ | SMD508399 | 80063 | HANDLE, BOARD | EA | 1 | |
| 14 | 2 | PAHZZ | 5961-00-615-0095 | 1N276 | 81349 | SEMICONDUCTOR, DIODE | EA 1 | |
| 14 | 3 | PAHZZ | 5905-00-825-2357 | RC07GF563K | 81349 | RESISTOR, FXD, CMPSN | EA 1 | |
| 14 | 4 | PAHZZ | 5905-00-110-7620 | RCR07G102JS | 81349 | RESISTOR, FXD, CMPSN | EA 2 | |
| 14 | 5 | XDHZZ | SMD508412-2 | 80063 | CAPACITOR, ELCTLT | EA | 3 | |
| 14 | 6 | XDHZZ | SMC508303 | 80063 | INSULATOR, DISK | EA | 6 | |
| 14 | 7 | PAHZZ | 5961-00-842-6937 | 2N706 | 81349 | TRANSISTOR | EA 4 | |
| 14 | 8 | XDHZZ | RC07GF482J | 81349 | RESISTOR, FXD, CMPSN | EA | 1 | |
| 14 | 9 | PAHZZ | 5905-00-686-9998 | RC07GF472J | 81349 | RESISTOR, FIXED, COMP | EA 1 | |
| 14 | 10 | XDHZZ | SMD508412-4 | 80063 | CAPACITOR, ELCTLT | EA | 10 | |
| 14 | 11 | PAHZZ | 5905-00-811-7912 | RC07GF470K | 81349 | RESISTOR, FXD, CMPSN | EA 2 | |
| 14 | 12 | PAHZZ | 5905-00-726-5340 | RC07GF101K | 81349 | RESISTOR, FXD, CMPSN | EA 4 | |
| 14 | 13 | XDHZZ | SMD508435-1 | 81349 | RESISTOR, FXD, FILM | EA | 1 | |
| 14 | 14 | PAHZZ | 5905-00-752-3340 | RC07GF472K | 81349 | RESISTOR, FXD, CMPSN | EA 3 | |
| 14 | 15 | PAHZZ | 5905-00-726-5346 | RC07GF182K | 81349 | RESISOR, FXD, CMPSN | EA 2 | |
| 14 | 16 | XDHZZ | SMD508442-3 | 80063 | RESISTOR, VARIABLE | EA | 2 | |
| 14 | 17 | PAHZZ | 5905-00-752-3335 | RC07GF122K | 81349 | RESISTOR, FXD, CMPSN | EA 1 | |
| 14 | 18 | PAHZZ | 5905-00-682-4098 | RC07GF392J | 81349 | RESISTOR, FXD, CMPSN | EA 2 | |
| 14 | 19 | PAHZZ | 5905-00-811-0674 | RC07GF391K | 81349 | RESISTOR, FXD, CMPSN | EA 2 | |
| 14 | 20 | PAHZZ | 5905-00-682-1101 | RC07GF224K | 81348 | RESISTOR, FXD, CMPSN | EA 2 | |
| 14 | 21 | PAHZZ | 5905-00-825-2360 | RC07GF221K | 81349 | RESISTOR, FXD, CMPSN | EA 2 | |
| 14 | 22 | XDHZZ | CL65CJ820MP3 | 81349 | CAPACITOR, ELCTLT | EA | 1 | |
| 14 | 23 | PAHZZ | 5910-00-954-7368 | CM05F241J03 | 81349 | CAPACITOR, FXD, MICA | EA 1 | |
| 14 | 24 | XDHZZ | SMD508555-1 | 80063 | SEMICONDUCTOR, DIODE | EA | 2 | |
| 14 | 25 | XDHZZ | CM05E820J03 | 81349 | CAPACITOR, FXD, MICA | EA | 2 | |
| 14 | 26 | XDHZZ | SMC508413-2 | 80063 | CAPACITOR, FXD, CER | EA | 2 | |
| 14 | 27 | PAHZZ | 5950-00-726-0166 | MS75052-7 | 96906 | CHOKE, RADIO, FREQ | EA 1 | |
| 14 | 28 | PAHZZ | 5905-00-752-3157 | RC07GF273K | 81349 | RESISTOR, FXD, CMPSM | EA 1 | |
| 14 | 29 | XDHZZ | SMD508415 | 80063 | CAPACITOR, FXD, CER | EA | 2 | |
| 14 | 30 | PAHZZ | 5961-00-686-8578 | 2N338 | 81349 | TRANSISTOR | EA 1 | |
| 14 | 31 | XDHZZ | SMC508413-1 | 80063 | CAPACITOR, FXD, CER | EA | 3 | |
| 14 | 32 | PAHZZ | 5905-00-110-8768 | RCR07G821JS | 81349 | RESISTOR, FXD, CMPSN | EA 1 | |
| 14 | 33 | XDHZZ | SMD508555-2 | 80063 | SEMICONDUCTOR, DIODE | EA | 2 | |
| 14 | 34 | PAHZZ | 5910-00-460-0868 | CM05F101J03 | 81349 | CAPACITOR, FXD, MICA | EA 2 | |
| 14 | 35 | PAHZZ | 5910-00-081-8526 | CM05F391J03 | 81349 | CAPACITOR, FXD, MICA | EA 1 | |
| 14 | 36 | XDHZZ | CM05F910G03 | 81349 | CAPACITOR, FXD, MICA | EA | 1 | |
| 14 | 37 | XDHZZ | SMD504321 | 80063 | CHOKE, RADIO, FREQ | EA | 1 | |
| 14 | 38 | PAHZZ | 5905-00-816-8554 | RC07GF103K | 81349 | RESISTOR, FXD, CMPSN | EA 1 | |
| 14 | 39 | PAHZZ | 5950-00-914-7724 | MS75053-4 | 96906 | CHOKE, RADIO, FREQ | EA 1 | |
| 14 | 40 | PAHZZ | 5905-00-686-4529 | RC07GF123K | 81349 | RESISTOR, FIXED, CMPSN | EA 3 | |

| SECTION II | | TM11-6625-467-24P | | | | | | |
|--------------|------|-------------------|------------------|-------------|-------------|-----------------------|------|---|
| (1) | (2) | (3) | (4) | (5) | (6) | (7) | (8) | |
| ILLUSTRATION | | | | | | | QTY | |
| (A) | (B) | NATIONAL | PART | FSCM | DESCRIPTION | USABLE ON CODE | INC | |
| FIG | ITEM | STOCK | NUMBER | | | | IN | |
| NO | NO | NUMBER | NUMBER | | | | UNIT | |
| 14 | 41 | PAHZZ | 5905-00-135-6046 | RC07GF681K | 81349 | RESISTOR, FIXED, COMP | EA | 1 |
| 14 | 42 | PAHZZ | 5905-00-726-6441 | RC07GF561K | 81349 | RESISTOR, FXD, CMPSN | EA | 1 |
| 14 | 43 | PAHZZ | 5905-00-752-3156 | RC07GF223K | 81349 | RESISTOR, FXD, CMPSN | EA | 1 |
| 14 | 44 | PAHZZ | 5905-00-726-6433 | RC07GF222K | 81349 | RESISTOR, FIXED, COMP | EA | 1 |
| 14 | 45 | XDHZZ | | SMD505017 | 80063 | TRANSISTOR | EA | 1 |
| 14 | 46 | XDHZZ | | SMC508318 | 80063 | PIN, STRAIGHT, HDLS | EA | 2 |
| 14 | 47 | XDHZZ | | SMD508370-3 | 80063 | JACK, TIP | EA | 1 |
| 14 | 48 | XDHZZ | | SMD508370-1 | 80063 | JACK, TIP | EA | 3 |
| 14 | 49 | PAHZZ | 5910-00-060-1194 | CM06F102J03 | 81349 | CAPACITOR, FXD, MICA | EA | 1 |
| 14 | 50 | XDHZZ | | SMD508435-2 | 81349 | RESISTOR, FXD, FILM | EA | 1 |
| 14 | 51 | XDHZZ | | MS91189-12 | 96906 | CHOKE, RADIO, FREQ | EA | 1 |
| 14 | 52 | PAHZZ | 5910-00-043-1996 | CM06F681J03 | 81349 | CAPACITOR, FXD, MICA | EA | 1 |
| 14 | 53 | PAHZZ | 5910-00-954-1769 | CM05F151J03 | 81349 | CAPACITOR, FXD, MICA | EA | 1 |



NOTE: FOR COMPLETE REFERENCE DESIGNATION
PREFIX WITH HU4A6

EL5ELO17

Figure 15. Test Set, Electronic Circuit Plug-In Unit AN/ARM-87, +28 Volt Regulator.

| SECTION II | | TM11-6625-467-24P | | | | | | |
|--------------|------|-------------------|-------------|-------|-----------------------|----------------|------|--|
| (1) | (2) | (3) | (4) | (5) | (6) | (7) | (8) | |
| ILLUSTRATION | | | | | | | | |
| (A) | (B) | NATIONAL | PART | FSCM | DESCRIPTION | USABLE ON CODE | U/M | |
| FIG | ITEM | STOCK | NUMBER | | | | | |
| NO | NO | NUMBER | NUMBER | | | | INC | |
| | | | | | | | IN | |
| | | | | | | | UNIT | |
| 15 | 1 | | SMD508399 | 80063 | HANDLE, BOARD | | EA 1 | |
| 15 | 2 | 5905-00-279-2672 | RC20GF182K | 81349 | RESISTOR, FXD, CMPSN | | EA 1 | |
| 15 | 3 | | SMD508442-4 | 80063 | RESISTOR, VARIABLE | | EA 1 | |
| 15 | 4 | | SMC508303 | 80063 | INSULATOR, DISK | | EA 5 | |
| 15 | 5 | 5961-00-813-9360 | 2N1613 | 81349 | TRANSISTOR | | EA 3 | |
| 15 | 6 | 5905-00-221-5860 | RC20GF334K | 81349 | RESISTOR, FXD, CMPSN | | EA 1 | |
| 15 | 7 | 5905-00-279-2286 | RC42GF821K | 81349 | RESISTOR, FXD, CMPSN | | EA 1 | |
| 15 | 8 | | SMD508441-2 | 80063 | CAPACITOR, FXD, PAPER | | EA 1 | |
| 15 | 9 | 5905-00-552-5057 | RC32GF182K | 81349 | RESISTOR, FXD, CMPSN | | EA 1 | |
| 15 | 10 | | RC42GF822K | 81349 | RESISTOR, FXD, CMPSN | | EA 1 | |
| 15 | 11 | | SMD508442-1 | 80063 | RESISTOR, VARIABLE | | EA 1 | |
| 15 | 12 | | SMD508441-1 | 80063 | CAPACITOR, FXD, PAPER | | EA 1 | |
| 15 | 13 | 5961-00-995-2310 | 1N752 | 81349 | SEMICONDUCTOR, DIODE | | EA 4 | |
| 15 | 14 | 5905-00-195-5507 | RC42GF122K | 81348 | RESISTOR, FXD, CMPSN | | EA 2 | |
| 15 | 15 | 5905-00-279-1756 | RC20GF151K | 81349 | RESISTOR, FXD, CMPSN | | EA 1 | |
| 15 | 16 | 5905-00-299-2019 | RC32GF223K | 81349 | RESISTOR, FXD, CMPSN | | EA 1 | |
| 15 | 17 | 5905-00-950-4378 | RN65D8253F | 81349 | RESISTOR, FXD, FILM | | EA 1 | |
| 15 | 18 | 5905-00-279-2607 | RC32GF681K | 81349 | RESISTOR, FXD, CMPSN | | EA 1 | |
| 15 | 19 | 5961-00-813-7283 | 2N1307 | 81349 | TRANSISTOR | | EA 2 | |
| 15 | 20 | | RC42GF681K | 81349 | RESISTOR, FXD, CMPSN | | EA 2 | |
| 15 | 21 | 5905-00-249-4248 | RC20GF333K | 81349 | RESISTOR, FXD, CMPSN | | EA 1 | |
| 15 | 22 | | SMC508432 | 80063 | CAPACITOR, FXD, PAPER | | EA 1 | |
| 15 | 23 | | SMC508318 | 80063 | PIN, STRAIGHT, HDLS | | EA 2 | |
| 15 | 24 | | SMD508370-1 | 80063 | JACK, TIP | | EA 4 | |
| 15 | 25 | | SMD508370-3 | 80063 | JACK, TIP | | EA 1 | |

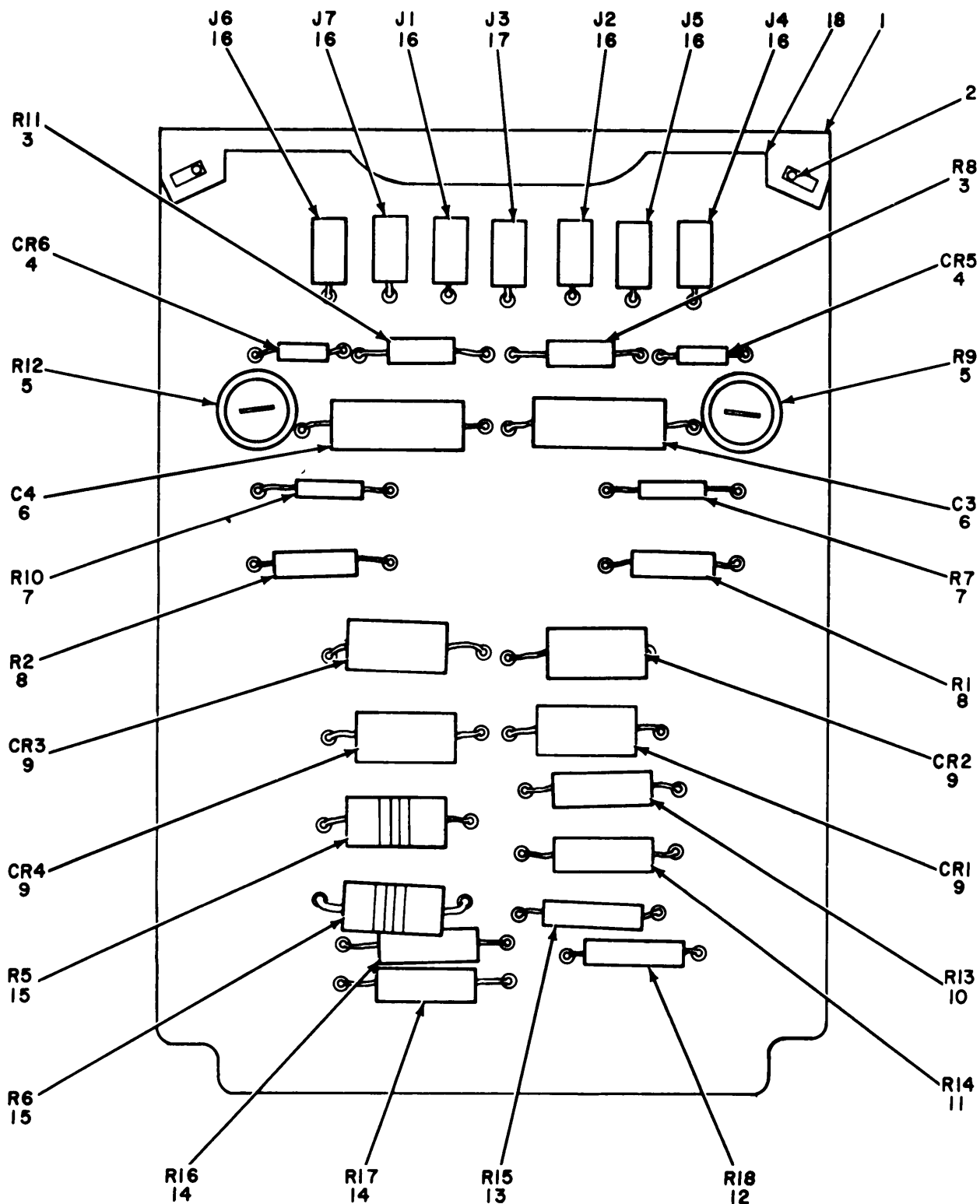

EL5ELO18

Figure 16. Test Set, Electronic Circuit Plug-In Unit AN/ARM-87, HV Power Supply Board.

| SECTION II | | TM11-6625-467-24P | | | | | | |
|--------------|------|-------------------|------------------|-------------|-------------|----------------------|------|---|
| (1) | (2) | (3) | (4) | (5) | (6) | (7) | (8) | |
| ILLUSTRATION | | | | | | | | |
| (A) | (B) | NATIONAL | PART | | DESCRIPTION | USABLE ON CODE | U/M | |
| FIG | ITEM | STOCK | NUMBER | FSCM | | | INC | |
| NO | NO | NUMBER | | | | | IN | |
| | | | | | | | UNIT | |
| 16 | 1 | XDHZZ | | SMD508399 | 80063 | HANDLE, BOARD | EA | 1 |
| 16 | 2 | XDHZZ | | SMC508318 | 80063 | PIN, STRAIGHT, HDLS | EA | 2 |
| 16 | 3 | PAHZZ | 5905-00-185-8518 | RC20GF103K | 81349 | RESISTOR, FXD, CMPSN | EA | 2 |
| 16 | 4 | PAHZZ | 5961-00-577-6084 | 1N645 | 81349 | SEMICONDUCTOR, DIODE | EA | 2 |
| 16 | 5 | XDHZZ | | SMD508442-4 | 80063 | RESISTOR, VARIABLE | EA | 2 |
| 16 | 6 | XDHZZ | | CS138226M | 81349 | CAPACITOR, FXD, ELEC | EA | 2 |
| 16 | 7 | PAHZZ | 5905-00-225-9390 | RN6007503F | 81349 | RESISTOR, FXD, FILM | EA | 2 |
| 16 | 8 | PAHZZ | 5905-00-064-0555 | RN65D1002F | 81349 | RESISTOR, FXD, FILM | EA | 2 |
| 16 | 9 | PAHZZ | 5961-00-688-6316 | 1N1096 | 81349 | SEMICONDUCTOR, DIODE | EA | 4 |
| 16 | 10 | XDHZZ | | RN7087503F | 81349 | RESISTOR, FXD, FILM | EA | 1 |
| 16 | 11 | PAHZZ | 5905-00-552-5716 | RN70B2374F | 81349 | RESISTOR, FXD, FILM | EA | 1 |
| 16 | 12 | XDHZZ | | RM65F1782F | 81349 | RESISTOR, FXD, FILM | EA | 1 |
| 16 | 13 | PAHZZ | 5905-00-989-5574 | RN65D1623F | 81349 | RESISTOR, FXD, FILM | EA | 1 |
| 16 | 14 | PAHZZ | 5905-00-732-3912 | RN70D10R0F | 81349 | RESISTOR, FXD, FILM | EA | 2 |
| 16 | 15 | PAHZZ | 5905-00-759-8896 | RC42GF104K | 81349 | RESISTOR, FXD, CMPSN | EA | 2 |
| 16 | 16 | XDHZZ | | SMD508370-1 | 80063 | JACK, TIP | EA | 6 |
| 16 | 17 | XDHZZ | | SMD508370-3 | 80063 | JACK, TIP | EA | 1 |
| 16 | 18 | XDHZZ | | SMD508505 | 80063 | PW, BOARD | EA | 1 |

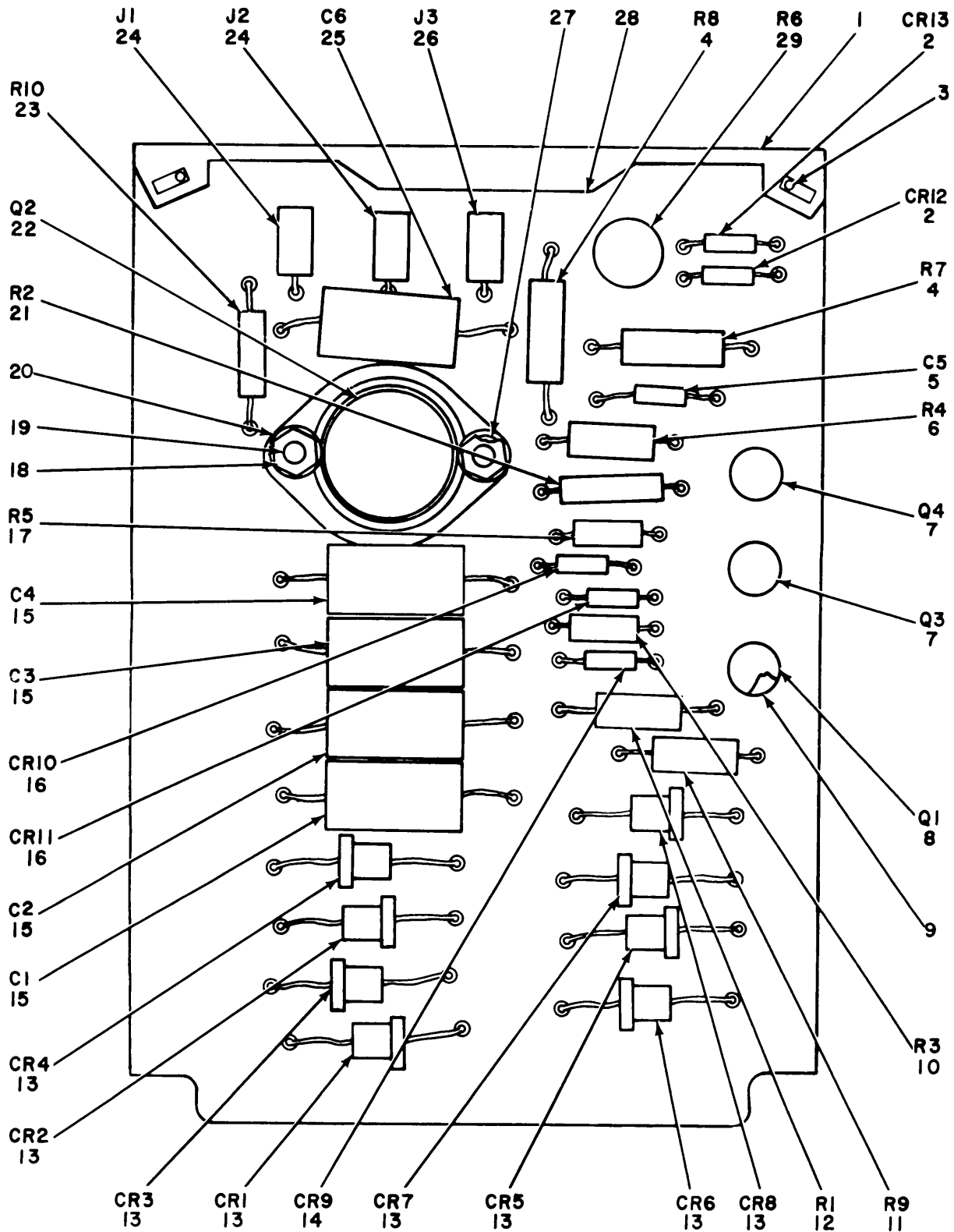

**NOTE: FOR COMPLETE REFERENCE DESIGNATION
PREFIX WITH HU3A8**

EL5ELO19

Figure 17. Test Set, Electronic Circuit Plug-In Unit AN/ARM-87, -28 Volt Regulator.

| SECTION II | | TM11-6625-467-24P | | | | | | |
|--------------|------|-------------------|------------------|--------------|-------------|------------------------|------|---|
| (1) | (2) | (3) | (4) | (5) | (6) | (7) | (8) | |
| ILLUSTRATION | | | | | | | | |
| (A) | (B) | | | | DESCRIPTION | | QTY | |
| FIG | ITEM | SMR | NATIONAL | PART | | USABLE ON CODE | INC | |
| NO | NO | CODE | STOCK | NUMBER | FSCM | | IN | |
| | | | NUMBER | | | | UNIT | |
| 17 | 1 | XDHZZ | | SMD508399 | 80063 | HANDLE, BOARD | EA | 1 |
| 17 | 2 | PAHZZ | 5961-00-852-7549 | 1N754A | 81349 | SEMICONDUCTOR, DIODE | EA | 2 |
| 17 | 3 | XDHZZ | | SMC508318 | 80063 | PIN, STRAIGHT, HDLS | EA | 2 |
| 17 | 4 | PAHZZ | 5905-00-990-2249 | RN70D5110F | 81349 | RESISTOR, FIXED, FILM | EA | 2 |
| 17 | 5 | PAHZZ | 5910-00-495-0042 | CRS13G105LK | 81349 | CAPACITOR, ELCTLT | EA | 1 |
| 17 | 6 | PAHZZ | 5905-00-087-6592 | RW69V3R9 | 81349 | RESISTOR, FXD, WW | EA | 1 |
| 17 | 7 | PAHZZ | 5961-00-845-3954 | 2N329A | 81349 | TRANSISTOR | EA | 2 |
| 17 | 8 | PAHZZ | 5961-00-813-9360 | 2N1613 | 81349 | TRANSISTOR | EA | 1 |
| 17 | 9 | XDHZZ | | SMC508303 | 80063 | INSULATOR, DISK | EA | 3 |
| 17 | 10 | PAHZZ | 5905-00-951-6735 | RW69V151 | 81349 | RESISTOR, FXD, WW | EA | 1 |
| 17 | 11 | PAHZZ | 5905-00-171-2005 | RC20GF471K | 81349 | RESISTOR, FXD, CMPSN | EA | 1 |
| 17 | 12 | PAHZZ | 5905-00-892-6799 | RW69V220 | 81349 | RESISTOR, FXD, WW | EA | 1 |
| 17 | 13 | PAHZZ | 5961-00-583-0897 | 1N1095 | 81349 | SEMICONDUCTOR, DIODE | EA | 8 |
| 17 | 14 | PAHZZ | 5961-00-847-5246 | 1N746A | 81349 | SEMICONDUCTOR, DIODE | EA | 1 |
| 17 | 15 | XDHZZ | | CL65CL560MP3 | 81349 | CAPACITOR, FXD, ELECLT | EA | 4 |
| 17 | 16 | PAHZZ | 5961-00-468-3651 | 1N751 | 81349 | SEMICONDUCTOR, DIODE | EA | 2 |
| 17 | 17 | PAHZZ | 5905-00-257-2631 | RC20GF821K | 81349 | RESISTOR, FXD, CMPSN | EA | 1 |
| 17 | 18 | PAHZZ | 5310-00-934-9761 | MS35649-264 | 96906 | NUT, PLAIN, HEXAGON | EA | 2 |
| 17 | 19 | PAHZZ | 5305-00-054-6653 | MS51957-29 | 96906 | SCREW, MACHINE | EA | 2 |
| 17 | 20 | PAHZZ | 5310-00-011-1041 | MS35338-79 | 96906 | WASHER, SPLIT | EA | 2 |
| 17 | 21 | PAHZZ | 5905-00-299-2044 | RC32GF222K | 81349 | RESISTOR, FXD, CMPSN | EA | 1 |
| 17 | 22 | PAHZZ | 5961-00-752-0218 | 2N297A | 81349 | TRANSISTOR | EA | 1 |
| 17 | 23 | PAHZZ | 5905-00-950-4378 | RN65D8253F | 81349 | RESISTOR, FXD, FILM | EA | 1 |
| 17 | 24 | XDHZZ | | SMD508370-1 | 80063 | JACK, TIP | EA | 2 |
| 17 | 25 | XDHZZ | | CL65CJ820MP3 | 80063 | CAPACITOR, ELCTLT | EA | 1 |
| 17 | 26 | XDHZZ | | SMD508370-3 | 80063 | JACK, TIP | EA | 1 |
| 17 | 27 | XDHZZ | | SMB504790 | 80063 | WASHER, FLAT | EA | 2 |
| 17 | 28 | XDHZZ | | SMD508482 | 80063 | PW, BOARD | EA | 1 |
| 17 | 29 | XDHZZ | | SMD508442-1 | 80063 | RESISTOR, VAR | EA | 1 |

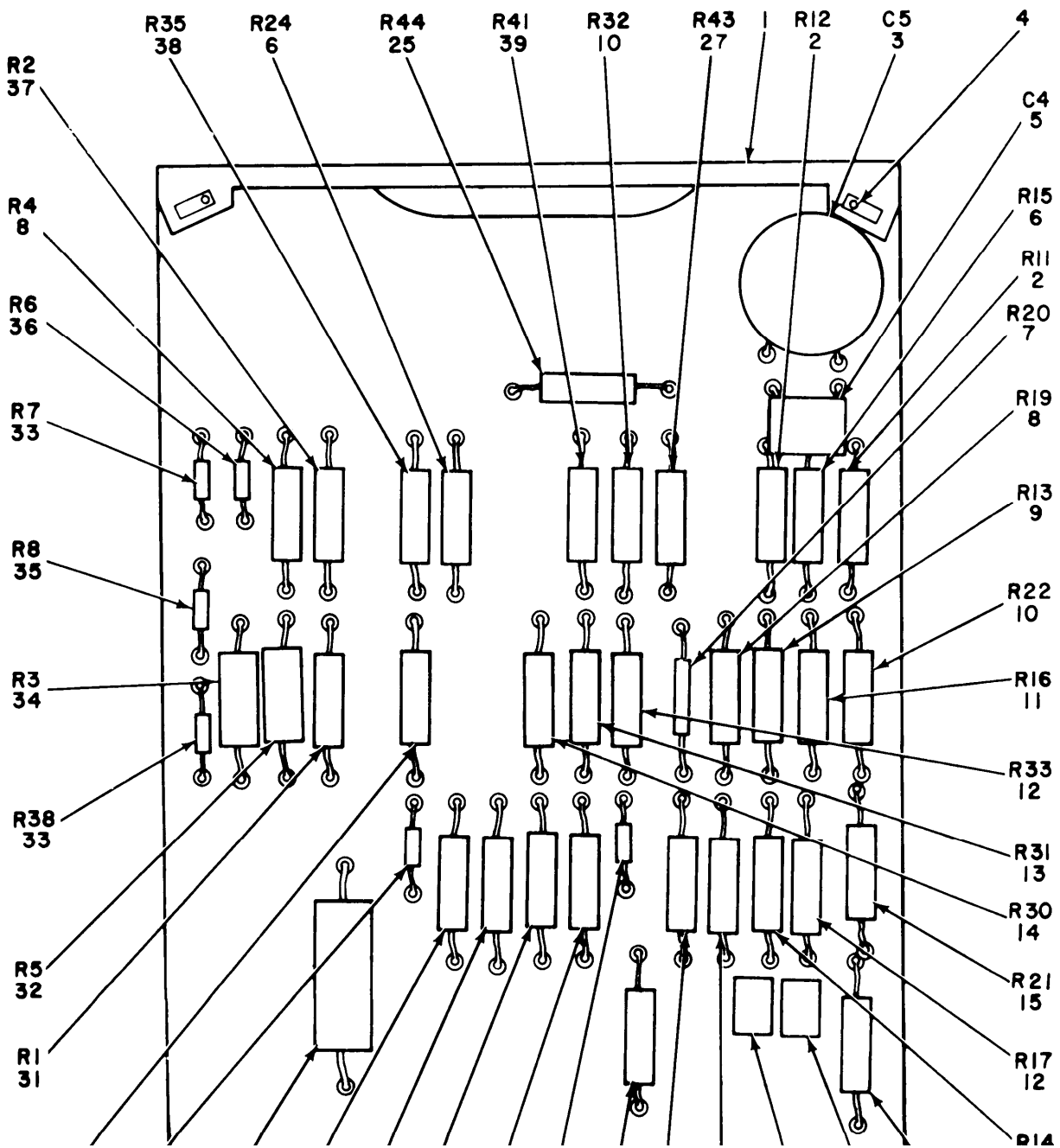

Figure 18. Test Set, Electronic Circuit Plug-In Unit AN/ARM-87, Load Assembly.

| SECTION II (1) ILLUSTRATION | | (2) | (3) | (4) | (5) | TM11-6625-467-24P (6) | (7) | (8) |
|-----------------------------------|-------------------|-------------|-----------------------------|----------------|-------|--------------------------|----------------|--------------------------|
| (A) FIG NO | (B) ITEM NO | SMR CODE | NATIONAL STOCK NUMBER | PART NUMBER | FSCM | DESCRIPTION | USABLE ON CODE | U/M INC IN UNIT |
| 18 | 1 | XDHZZ | | SMD508399 | 80063 | HANDLE, BOARD | EA | 1 |
| 18 | 2 | XDHZZ | 5905-00-088-3355 | RN65D1960F | 81349 | RESISTOR, FXD, FILM | EA | 2 |
| 18 | 3 | XDHZZ | | SMD508415 | 80063 | CAPACITOR, FXD, CER | EA | 1 |
| 18 | 4 | XDHZZ | | SMC508318 | 80063 | PIN, STRAIGHT, HDLS | EA | 2 |
| 18 | 5 | XDHZZ | | SMD508417 | 80063 | CAPACITOR, FXD, CER | EA | 1 |
| 18 | 6 | PAHZZ | 5905-00-958-3498 | RN65D51R1F | 81349 | RESISTOR, FXD, FILM | EA | 2 |
| 18 | 7 | PAHZZ | 5905-00-069-3910 | RN60D1470F | 81349 | RESISTOR, FXD, FILM | EA | 1 |
| 18 | 8 | XDHZZ | 5905-00-989-5580 | RN65D5110F | 81349 | RESISTOR, FXD, FILM | EA | 2 |
| 18 | 9 | PAHZZ | 5905-00-952-9428 | RN65D34R8F | 81349 | RESISTOR, FXD, FILM | EA | 1 |
| 18 | 10 | PAHZZ | 5905-00-063-8405 | RN65D2151F | 81349 | RESISTOR, FXD, FILM | EA | 2 |
| 18 | 11 | XDHZZ | | RN65D2601F | 81349 | RESISTOR, FXD, FILM | EA | 1 |
| 18 | 12 | PAHZZ | 5905-00-993-1362 | RN65D3161F | 81349 | RESISTOR, FXD, FILM | EA | 2 |
| 18 | 13 | PAHZZ | 5905-00-993-6975 | RN65D1781F | 81349 | RESISTOR, FXD, FILM | EA | 1 |
| 18 | 14 | PAHZZ | 5905-00-062-0538 | RN65D3832F | 81349 | RESISTOR, FXD, FILM | EA | 1 |
| 18 | 15 | PAHZZ | 5905-00-060-2481 | RN65D6811F | 81349 | RESISTOR, FXD, FILM | EA | 1 |
| 18 | 16 | PAHZZ | 5905-00-951-4045 | RN65D4641F | 81349 | RESISTOR, FXD, FILM | EA | 1 |
| 18 | 17 | PAHZZ | 5905-00-855-7207 | RN65D1472F | 81349 | RESISTOR, FXD, FILM | EA | 1 |
| 18 | 18 | XDHZZ | | SMD508412-2 | 80063 | CAPACITOR, FXD, ELCLT | EA | 1 |
| 18 | 19 | XDHZZ | | SMD508412-3 | 80063 | CAPACITOR, FXD, ELCLT | EA | 1 |
| 18 | 20 | PAHZZ | 5905-00-952-9435 | RN65D9092F | 81349 | RESISTOR, FXD, FILM | EA | 1 |
| 18 | 21 | PAHZZ | 5905-00-993-1365 | RN65D2871F | 81349 | RESISTOR, FXD, FILM | EA | 1 |
| 18 | 22 | PAHZZ | 5905-00-993-2263 | RN65D4221F | 81349 | RESISTOR, FXD, FILM | EA | 1 |
| 18 | 23 | PAHZZ | 5905-00-686-3131 | RC07GF334J | 81349 | RESISTOR, FXD, CMPSN | EA | 1 |
| 18 | 24 | PAHZZ | 5905-00-079-4382 | RN65D1333F | 80063 | RESISTOR, FXD, FILM | EA | 1 |
| 18 | 25 | PAHZZ | 5905-00-993-6012 | RN65D1471F | 81349 | RESISTOR, FXD, FILM | EA | 2 |
| 18 | 26 | PAHZZ | 5905-00-892-7283 | RN65D7501F | 81349 | RESISTOR, FXD, FILM | EA | 1 |
| 18 | 27 | PAHZZ | 5905-00-062-5039 | RN65D1211F | 81349 | RESISTOR, FXD, FILM | EA | 2 |
| 18 | 28 | XDHZZ | | SMD508434 | 80063 | CAPACITOR, FXD, PAPER | EA | 1 |
| 18 | 29 | PAHZZ | 5905-00-726-5345 | RC07GF154K | 81349 | RESISTOR, FXD, CMPSN | EA | 1 |
| 18 | 30 | PAHZZ | 5905-00-951-5754 | RN65D1052F | 81349 | RESISTOR, FXD, FILM | EA | 1 |
| 18 | 31 | PAHZZ | 5905-00-088-3101 | RN65D2870F | 81349 | RESISTOR, FXD, FILM | EA | 1 |
| 18 | 32 | PAHZZ | 5905-00-984-7709 | RN65D1622F | 81349 | RESISTOR, FXD, FILM | EA | 1 |
| 18 | 33 | PAHZZ | 5905-00-752-3156 | RC07GF223K | 81349 | RESISTOR, FXD, CMPSN | EA | 2 |
| 18 | 34 | PAHZZ | 5905-00-892-6464 | RN65D2373F | 81349 | RESISTOR, FXD, FILM | EA | 1 |
| 18 | 35 | PAHZZ | 5905-00-688-3475 | RC07GF474K | 81349 | RESISTOR, FXD, CMPSN | EA | 1 |
| 18 | 36 | PAHZZ | 5905-00-752-3340 | RC07GF472K | 81349 | RESISTOR, FXD, CMPSN | EA | 1 |
| 18 | 37 | PAHZZ | 5905-00-993-1353 | RN65D46R4F | 81349 | RESISTOR, FXD, FILM | EA | 1 |
| 18 | 38 | PAHZZ | 5905-00-964-2376 | RN65D1101F | 81349 | RESISTOR, FXD, FILM | EA | 1 |
| 18 | 39 | PAHZZ | 5905-00-950-6790 | RN65D1331F | 81349 | RESISTOR, FXD, FILM | EA | 1 |

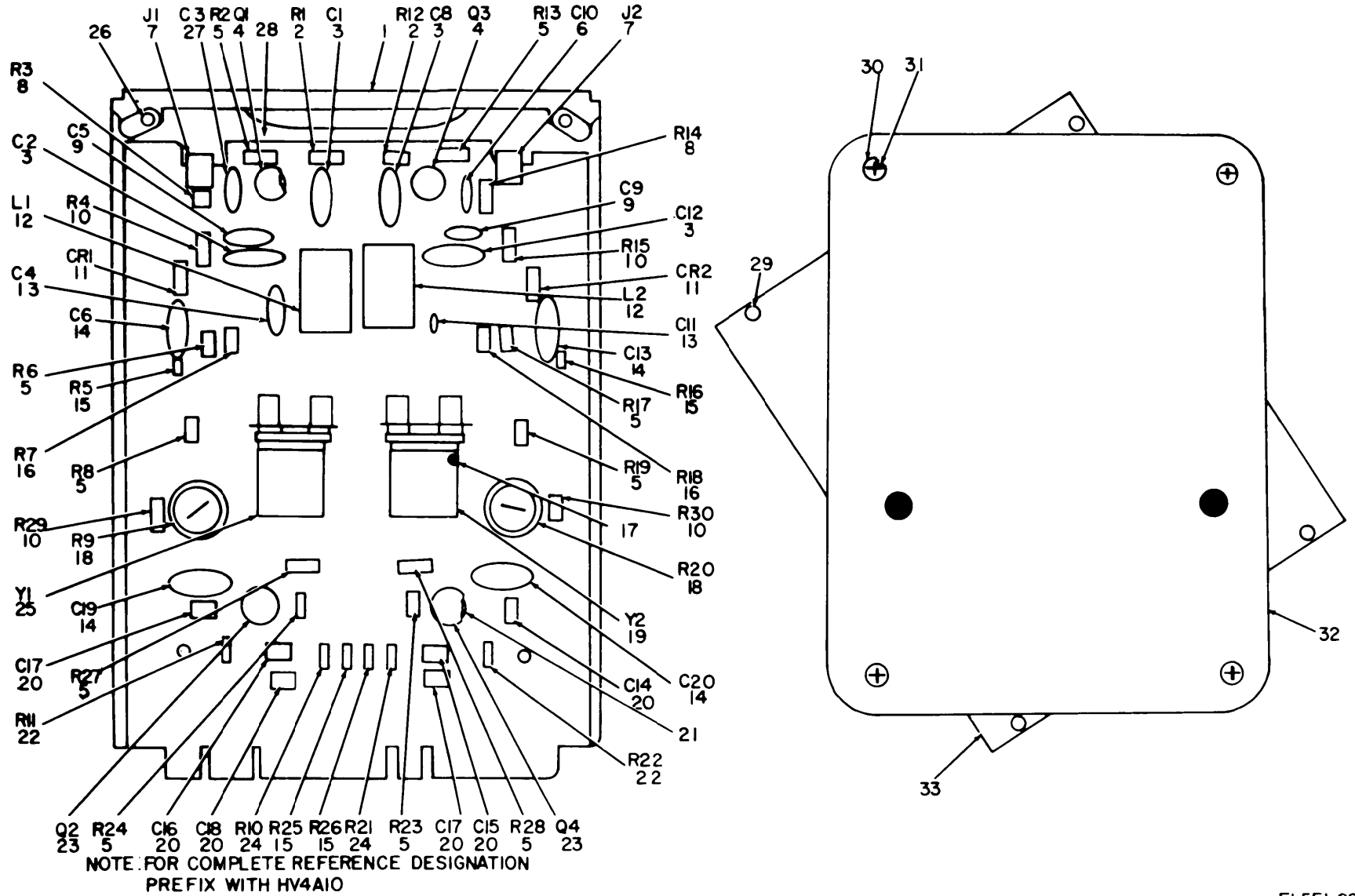
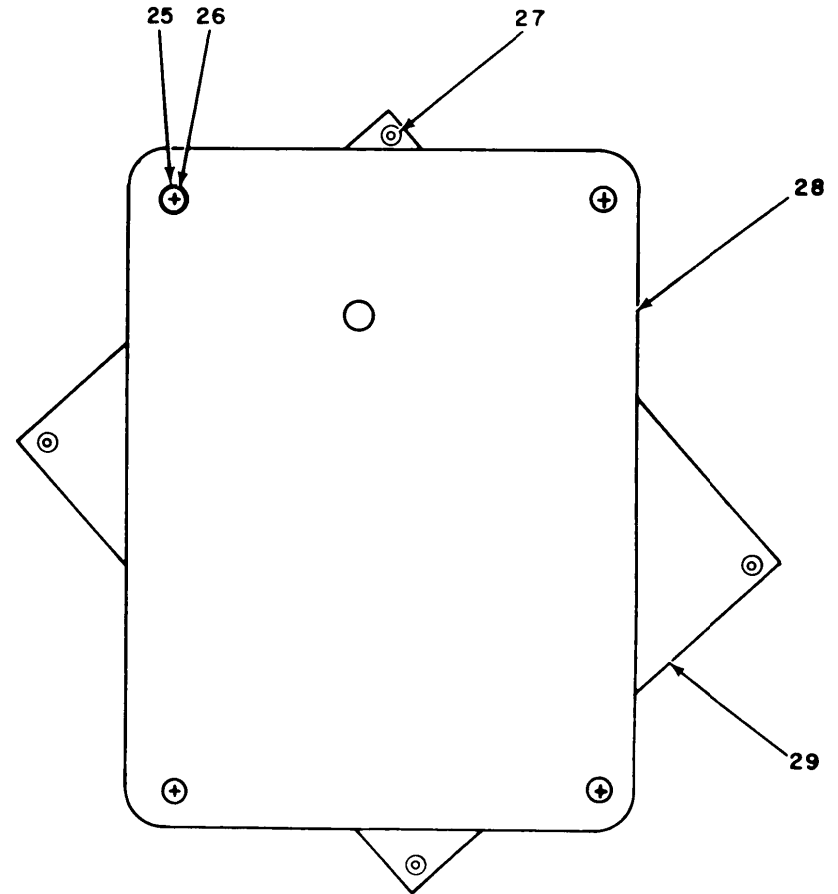
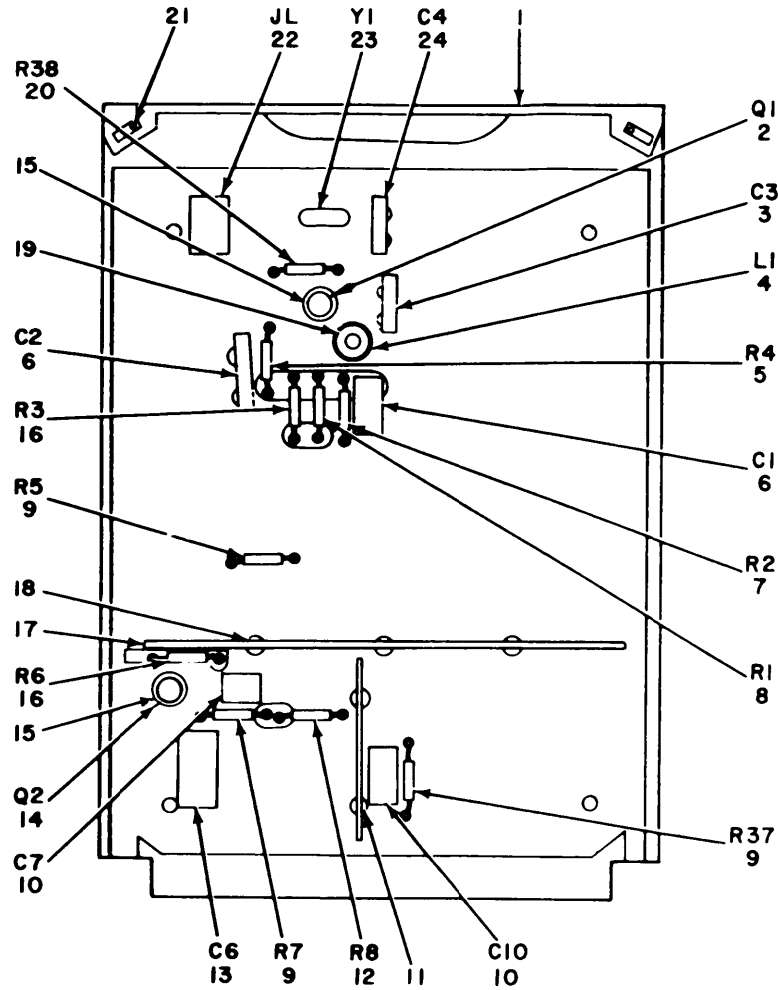

Figure 19. Test Set, Electronic Circuit Plug-In Unit AN/ARM-87, 3.975/5.925-MHz Oscillator.

EL5EL021

| SECTION II | | TM11-6625-467-24P | | | | | | |
|--------------|------|-------------------|------------------|-------------|------------------------|----------------------|-------|--|
| (1) | (2) | (3) | (4) | (5) | (6) | (7) | (8) | |
| ILLUSTRATION | | | | | | | | |
| (A) | (B) | NATIONAL | PART | FSCM | DESCRIPTION | USABLE ON CODE | U/M | |
| FIG | ITEM | STOCK | NUMBER | | | | | |
| NO | NO | NUMBER | | | | | INC | |
| | | | | | | | IN | |
| | | | | | | | UNIT | |
| 19 | 1 | XDHZZ | SMD508399 | 80063 | HANDLE, BOARD | | EA 1 | |
| 19 | 2 | PAHZZ | 5905-00-752-3156 | RC07GF223K | 81349 | RESISTOR, FXD, CMPSN | EA 2 | |
| 19 | 3 | PAHZZ | 5910-00-060-1194 | CM06F102J03 | 81349 | CAPACITOR, FXD, MICA | EA 4 | |
| 19 | 4 | PAHZZ | 5961-00-686-8578 | 2N338 | 81349 | TRANSISTOR | EA 2 | |
| 19 | 5 | PAHZZ | 5905-00-752-3340 | RC07GF472K | 81349 | RESISTOR, FXD, CMPSN | EA 10 | |
| 19 | 6 | XDHZZ | CM05F221J03 | 81349 | CAPACITOR, FXD, MICA | | EA 1 | |
| 19 | 7 | XDHZZ | SMD508370-2 | 80063 | JACK, TIP | | EA 2 | |
| 19 | 8 | PAHZZ | 5905-00-752-3335 | RC07GF122K | 81349 | RESISTOR, FXD, CMPSN | EA 2 | |
| 19 | 9 | PAHZZ | 5910-00-051-4610 | CM05E680J03 | 81349 | CAPACITOR, FXD, MICA | EA 2 | |
| 19 | 10 | PAHZZ | 5905-00-816-8554 | RC07GF103K | 81349 | RESISTOR, FXD, CMPSN | EA 4 | |
| 19 | 11 | PAHZZ | 5961-00-022-5664 | 1N914 | 81349 | SEMICONDUCTOR, DIODE | EA 2 | |
| 19 | 12 | XDHZZ | SMC508340-2 | 80063 | CHOKE, RADIO, FREQ | | EA 2 | |
| 19 | 13 | PAHZZ | 5910-00-954-1772 | CM05E470J03 | 81349 | CAPACITOR, FXD, MICA | EA 2 | |
| 19 | 14 | PAHZZ | 5910-00-051-4641 | CM06F472J03 | 81349 | CAPACITOR, FXD, MICA | EA 4 | |
| 19 | 15 | PAHZZ | 5905-00-811-7912 | RC07GF470K | 81349 | RESISTOR, FXD, CMPSN | EA 4 | |
| 19 | 16 | PAHZZ | 5905-00-755-0797 | RC07GF560K | 81349 | RESISTOR, FXD, CMPSN | EA 2 | |
| 19 | 17 | PAHZZ | 5320-00-753-3942 | MS16535-52 | 96906 | RIVET, TUBULAR | EA 2 | |
| 19 | 18 | XDHZZ | SMD508442-4 | 80063 | RESISTOR, VARIABLE | | EA 2 | |
| 19 | 19 | XDHZZ | CR18AU3-975MC | 81349 | CRYSTAL UNIT, QUARTZ | | EA 1 | |
| 19 | 20 | XDHZZ | SMD508412-1 | 80063 | CAPACITOR, FXD, ELECLT | | EA 6 | |
| 19 | 21 | XDHZZ | SMC508303 | 80063 | INSULATOR, DISK | | EA 4 | |
| 19 | 22 | PAHZZ | 5905-00-726-5340 | RC07GF101K | 81349 | RESISTOR, FXD, CMPSN | EA 2 | |
| 19 | 23 | XDHZZ | SMD505017 | 80063 | TRANSISTOR | | EA 1 | |
| 19 | 24 | PAHZZ | 5905-00-726-6441 | RC07GF561K | 81349 | RESISTOR, FXD, CMPSN | EA 2 | |
| 19 | 25 | XDHZZ | CR18AU5-925MC | 81349 | CRYSTAL UNIT, QUARTZ | | EA 1 | |
| 19 | 26 | XDHZZ | SMC508318 | 80063 | PIN, STRAIGHT, HDLS | | EA 2 | |
| 19 | 27 | PAHZZ | 5910-00-954-1769 | CMD5F151J03 | 81349 | CAPACITOR, FXD, MICA | EA 1 | |
| 19 | 28 | XDHZZ | SMD508489 | 80063 | PW BOARD | | EA 1 | |
| 19 | 29 | XDHZZ | SMB508346 | 80063 | SLEEVE, RETAINING | | EA 4 | |
| 19 | 30 | XDHZZ | SMB508338 | 80063 | SCREW, MACHINE | | EA 4 | |
| 19 | 31 | PAHZZ | 5310-00-933-8118 | MS35338-78 | 96906 | WASHER, SPLIT | EA 4 | |
| 19 | 32 | XDHZZ | SMD508387 | 80063 | COVER, BOARD | | EA 1 | |
| 19 | 33 | XDHZZ | SMD508439 | 80063 | PLATE MOUNTING | | EA 1 | |



EL5ELO22

Figure 20. Test Set, Electronic Circuit Plug-In Unit AN/ARM-87, 30-MHz Oscillator.

| SECTION II | | TM11-6625-467-24P | | | | | | |
|--------------|------|-------------------|------------------|-------------|-------------|-------------------------|------|---|
| (1) | (2) | (3) | (4) | (5) | (6) | (7) | (8) | |
| ILLUSTRATION | | | | | | | | |
| (A) | (B) | NATIONAL | PART | | DESCRIPTION | | QTY | |
| FIG | ITEM | STOCK | NUMBER | FSCM | | USABLE ON CODE | INC | |
| NO | NO | NUMBER | NUMBER | | | | IN | |
| | | | | | | | UNIT | |
| 20 | 1 | XDHZZ | | SMD508399 | 80063 | HANDLE, BOARD | EA | 1 |
| 20 | 2 | XDHZZ | | SMD504017 | 80063 | TRANSISTOR | EA | 1 |
| 20 | 3 | PAHZZ | 5910-00-088-0283 | CM05E390J03 | 81349 | CAPACITOR, FXD, MICA | EA | 1 |
| 20 | 4 | XDHZZ | | SMD504497-3 | 80063 | COIL, RADIO, FREQ | EA | 1 |
| 20 | 5 | PAHZZ | 5905-00-726-6836 | RC07GF680K | 81349 | RESISTOR, FXD, CMPSN | EA | 1 |
| 20 | 6 | PAHZZ | 5910-00-957-8582 | CM06F222J03 | 81349 | CAPACITOR, FXD, MICA | EA | 2 |
| 20 | 7 | PAHZZ | 5905-00-686-4529 | RC07GF123K | 81349 | RESISTOR, FXD, CMPSN | EA | 1 |
| 20 | 8 | PAHZZ | 5905-00-811-0673 | RC07GF682K | 81349 | RESISTOR, FXD, CMPSN | EA | 1 |
| 20 | 9 | PAHZZ | 5905-00-811-7912 | RC07GF470K | 81349 | RESISTOR, FXD, CMPSN | EA | 3 |
| 20 | 10 | XDHZZ | | SMD508412-1 | 80063 | CAPACITOR, FXD, ELECCLT | EA | 2 |
| 20 | 11 | XDHZZ | | SMC508392 | 80063 | PARTITION | EA | 1 |
| 20 | 12 | PAHZZ | 5905-00-726-6834 | RC07GF562K | 81349 | RESISTOR, FXD, CMPSN | EA | 1 |
| 20 | 13 | PAHZZ | 5910-00-051-4641 | CM06F472J03 | 81349 | CAPACITOR, FXD, MICA | EA | 1 |
| 20 | 14 | XDHZZ | | SMD508311 | 80063 | TRANSISTOR | EA | 1 |
| 20 | 15 | XDHZZ | | SMC508303 | 80063 | INSULATOR, DISK | EA | 2 |
| 20 | 16 | PAHZZ | 5905-00-726-6433 | RC07GF222K | 81349 | RESISTOR, FIXED, COMP | EA | 2 |
| 20 | 17 | XDHZZ | | SMC508397 | 80063 | PARTITION | EA | 1 |
| 20 | 18 | PAHZZ | 5305-00-054-5648 | MS51957-14 | 96906 | SCREW, MACHINE | EA | 5 |
| 20 | 19 | PAHZZ | 5305-00-054-5646 | MS51957-12 | 96906 | SCREW, MACHINE | EA | 1 |
| 20 | 20 | PAHZZ | 5905-00-816-8554 | RC07GF103K | 81349 | RESISTOR, FXD, CMPSN | EA | 1 |
| 20 | 21 | XDHZZ | | SMC508318 | 80063 | PIN, STRAIGHT, HDLS | EA | 2 |
| 20 | 22 | XDHZZ | | SMD508370-1 | 80063 | JACK, TIP | EA | 1 |
| 20 | 23 | XDHZZ | | SMC508316 | 80063 | CRYSTAL UNIT, QUARTZ | EA | 1 |
| 20 | 24 | PAHZZ | 5910-00-954-5502 | CM05F131J03 | 81349 | CAPACITOR, FXD, MICA | EA | 1 |
| 20 | 25 | PAHZZ | 5310-00-933-8118 | MS35338-78 | 96906 | WASHER, SPLIT | EA | 4 |
| 20 | 26 | XDHZZ | | SMB508338 | 80063 | SCREW, MACHINE | EA | 4 |
| 20 | 27 | XDHZZ | | SMB508346 | 80063 | SLEEVE, RETAINING | EA | 4 |
| 20 | 28 | XDHZZ | | SMD508390 | 80063 | COVER, BOARD | EA | 1 |
| 20 | 29 | XDHZZ | | SMD508439 | 80063 | PLATE, MOUNTING | EA | 1 |

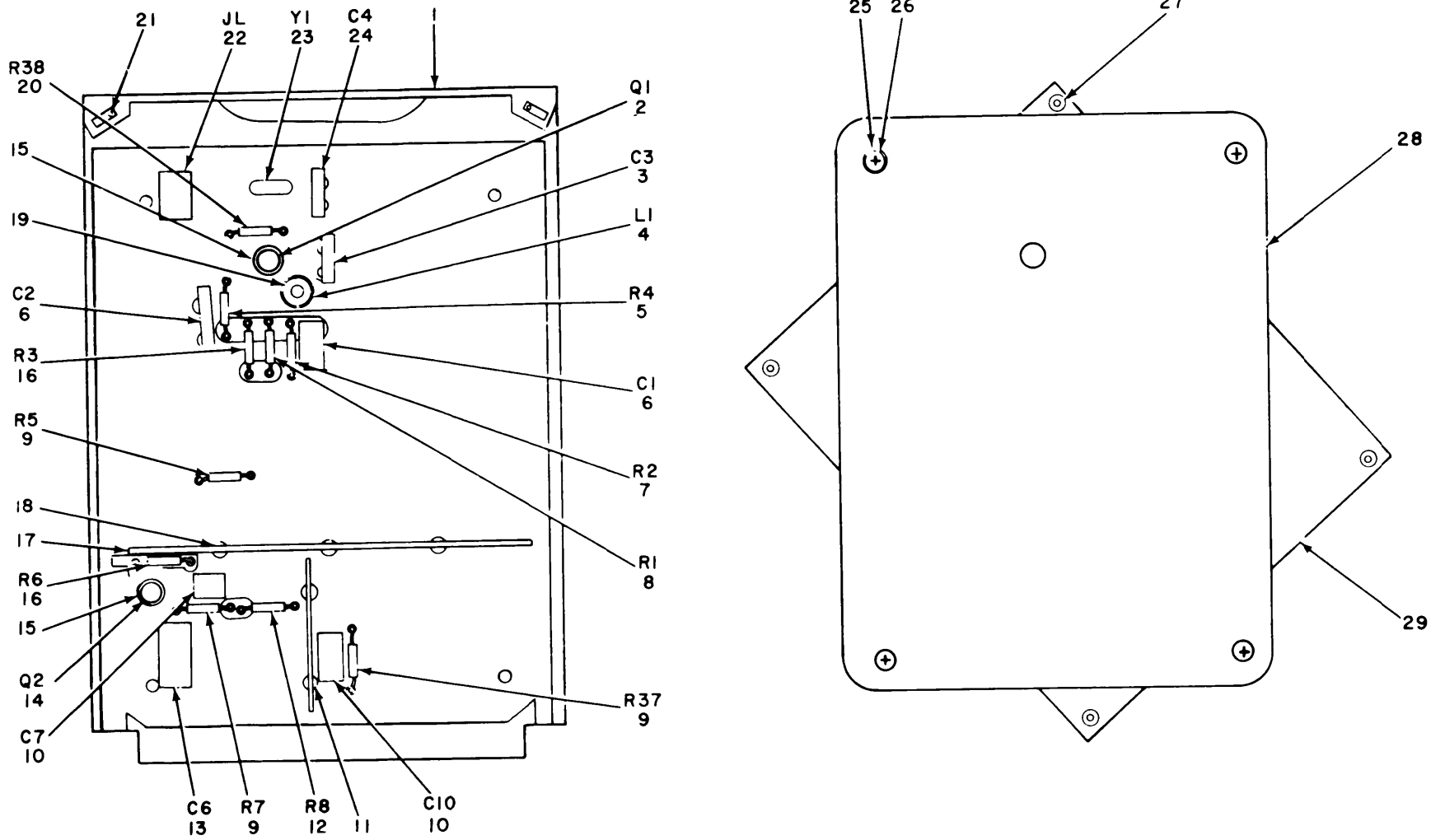

NOTE: FOR COMPLETE REFERENCE DESIGNATION
PREFIX WITH HW2A12

EL5EL023

Figure 21. Test Set, Electronic Circuit Plug-In Unit AN/ARM-87, 68-MHz Oscillator.

| SECTION II (1) ILLUSTRATION (A) (B) FIG ITEM NO NO | | (2) SMR CODE | (3) NATIONAL STOCK NUMBER | (4) PART NUMBER | (5) FSCM | TM11-6625-467-24P (6) DESCRIPTION | USABLE ON CODE | (7) U/M | (8) QTY INC IN UNIT |
|---|----|--------------------|------------------------------------|-----------------------|-------------|---|----------------|------------|---------------------------------|
| 21 | 1 | XDHZZ | | SMD508399 | 80063 | HANDLE, BOARD | | EA | 1 |
| 21 | 2 | XDHZZ | | SMD504017 | 80063 | TRANSISTOR | | EA | 1 |
| 21 | 3 | PAHZZ | 5910-00-067-5697 | CM05E270J03 | 81349 | CAPACITOR, FXD, MICA | | EA | 1 |
| 21 | 4 | XDHZZ | | SMD504497-17 | 80063 | COIL, RADIO, FREQ | | EA | 1 |
| 21 | 5 | PAHZZ | 5905-00-726-6836 | RC07GF680K | 81349 | RESISTOR, FXD, CMPSN | | EA | 1 |
| 21 | 6 | PAHZZ | 5910-00-957-8582 | CM06F222J03 | 81349 | CAPACITOR, FXD, MICA | | EA | 2 |
| 21 | 7 | PAHZZ | 5905-00-686-4529 | RC07GF123K | 81349 | RESISTOR, FXD, CMPSN | | EA | 1 |
| 21 | 8 | PAHZZ | 5905-00-811-0673 | RC07GF682K | 81349 | RESISTOR, FXD, CMPSN | | EA | 1 |
| 21 | 9 | PAHZZ | 5905-00-811-7912 | RC07GF470K | 81349 | RESISTOR, FXD, CMPSN | | EA | 3 |
| 21 | 10 | XDHZZ | | SMD508412-1 | 80063 | CAPACITOR, FXD, ELCLT | | EA | 2 |
| 21 | 11 | XDHZZ | | SMC508392 | 80063 | PARTITION | | EA | 1 |
| 21 | 12 | PAHZZ | 5905-00-726-6834 | RC07GF562K | 81349 | RESISTOR, FXD, CMPSN | | EA | 1 |
| 21 | 13 | PAHZZ | 5910-00-051-4641 | CM06F472J03 | 81349 | CAPACITOR, FXD, MICA | | EA | 1 |
| 21 | 14 | XDHZZ | | SMD508311 | 80063 | TRANSISTOR | | EA | 1 |
| 21 | 15 | XDHZZ | | SMC508303 | 80063 | INSULATOR, DISK | | EA | 2 |
| 21 | 16 | PAHZZ | 5905-00-726-6433 | RC07GF222K | 81349 | RESISTOR, FIXED, COMP | | EA | 2 |
| 21 | 17 | XDHZZ | | SMC508397 | 80063 | PARTITION | | EA | 1 |
| 21 | 18 | PAHZZ | 5305-00-054-5648 | MS51957-14 | 96906 | SCREW, MACHINE | | EA | 5 |
| 21 | 19 | PAHZZ | 5305-00-054-5646 | MS51957-12 | 96906 | SCREW, MACHINE | | EA | 1 |
| 21 | 20 | PAHZZ | 5905-00-816-8554 | RC07GF103K | 81349 | RESISTOR, FXD, CMPSN | | EA | 1 |
| 21 | 21 | XDHZZ | | SMC508318 | 80063 | PIN, STRAIGHT, HDLS | | EA | 2 |
| 21 | 22 | XDHZZ | | SMD508370-1 | 80063 | JACK, TIP | | EA | 1 |
| 21 | 23 | PAHZZ | 5955-00-043-1204 | CR56AU | 81349 | CRYSTAL UNIT, QUARTZ | | EA | 1 |
| 21 | 24 | PAHZZ | 5910-00-954-5502 | CM05F131J03 | 81349 | CAPACITOR, FXD, MICA | | EA | 1 |
| 21 | 25 | PAHZZ | 5310-00-933-8118 | MS35338-78 | 96906 | WASHER, SPLIT | | EA | 4 |
| 21 | 26 | XDHZZ | | SMB508338 | 80063 | SCREW, MACHINE | | EA | 4 |
| 21 | 27 | XDHZZ | | SMD508346 | 80063 | SLEEVE, RETAINING | | EA | 4 |
| 21 | 28 | XDHZZ | | SMD508390 | 80063 | COVER, BOARD | | EA | 1 |
| 21 | 29 | XDHZZ | | SMD508439 | 80063 | PLATE, MOUNTING | | EA | 1 |

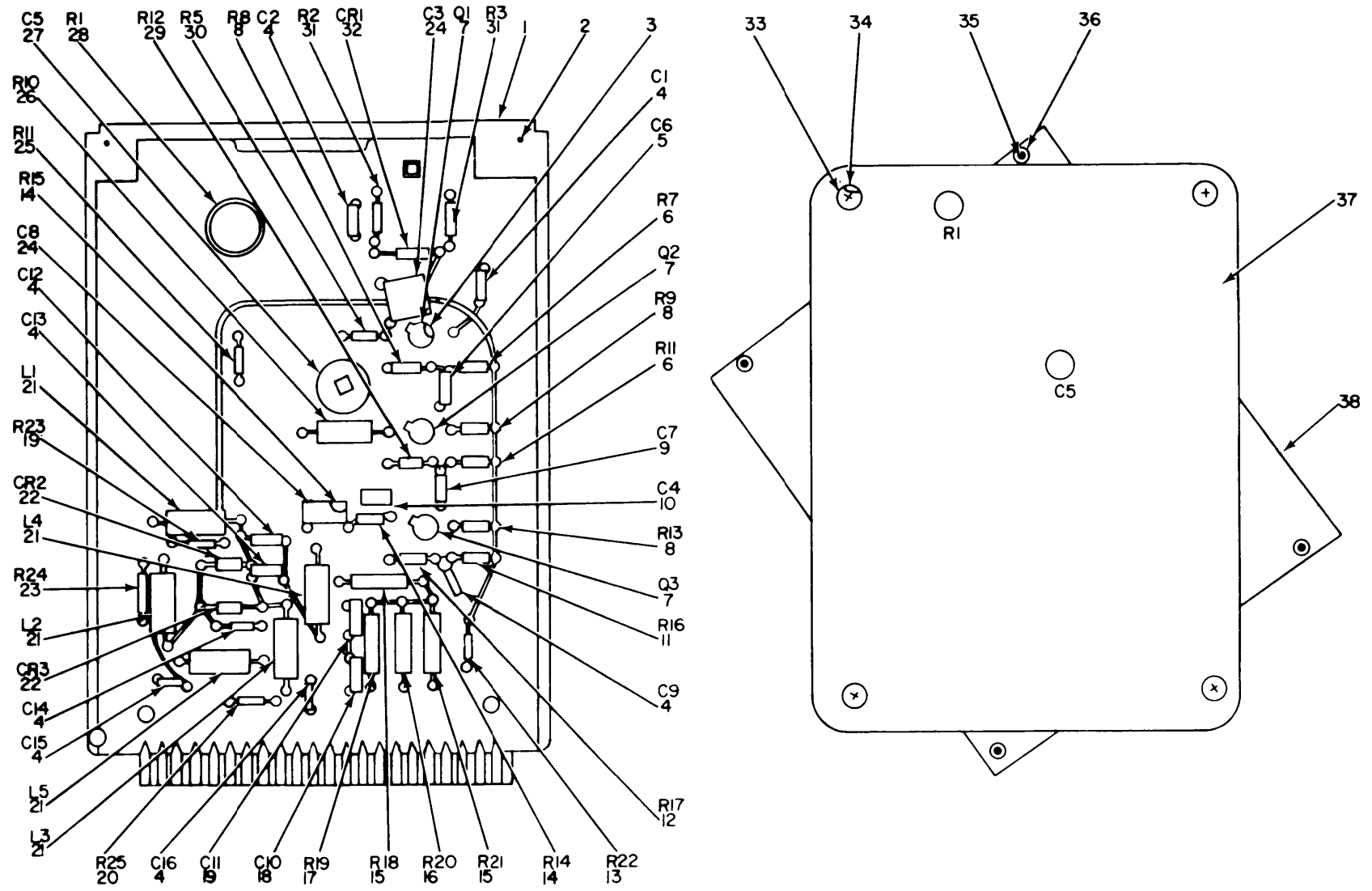

NOTE: FOR COMPLETE REFERENCE DESIGNATION
 PREFIX WITH HV3A13

EL5ELO24

Figure 22. Test Set, Electronic Circuit Plug-In Unit AN/ARM-87, Amplifier Detector.

| SECTION II (1) ILLUSTRATION (A) FIG NO | | (2) SMR CODE | (3) NATIONAL STOCK NUMBER | (4) PART NUMBER | (5) FSCM | TM11-6625-467-24P (6) DESCRIPTION | (7) USABLE ON CODE | U/M | (8) QTY INC IN UNIT |
|---|----|--------------------|------------------------------------|-----------------------|-------------|---|-----------------------|-----|---------------------------------|
| 22 | 1 | XDHZZ | | SMD508399 | 80063 | HANDLE, BOARD | | EA | 1 |
| 22 | 2 | XDHZZ | | SMC508318 | 80063 | PIN, STRAIGHT, HDLS | | EA | 2 |
| 22 | 3 | XDHZZ | | SMC508303 | 80063 | INSULATOR, DISK | | EA | 2 |
| 22 | 4 | XDHZZ | | 805014XV0103Z | 72982 | CAPACITOR, CERAMIC | | EA | 7 |
| 22 | 5 | PAHZZ | 5910-00-880-6080 | CM06F122J03 | 81349 | CAPACITOR, FXD, MICA | | EA | 1 |
| 22 | 6 | PAHZZ | 5905-00-686-9998 | RC07GF472J | 81349 | RESISTOR, FXD, CMPSN | | EA | 2 |
| 22 | 7 | XDHZZ | | SMD508311 | 80063 | TRANSISTOR | | EA | 3 |
| 22 | 8 | PAHZZ | 5905-00-110-7620 | RCR07G102JS | 81349 | RESISTOR, FXD, CMPSN | | EA | 3 |
| 22 | 9 | XDHZZ | | CM05E820J03 | 81349 | CAPACITOR, FXD, MICA | | EA | 1 |
| 22 | 10 | PAHZZ | 5910-00-460-0868 | CM05F101J03 | 81349 | CAPACITOR, FXD, MICA | | EA | 1 |
| 22 | 11 | PAHZZ | 5905-00-726-6834 | RC07GF562K | 81349 | RESISTOR, FXD, CMPSN | | EA | 1 |
| 22 | 12 | PAHZZ | 5905-00-686-4525 | RC07GF271K | 81349 | RESISTOR, FXD, CMPSN | | EA | 1 |
| 22 | 13 | PAHZZ | 5905-00-726-5340 | RC07GF101K | 81349 | RESISTOR, FXD, CMPSN | | EA | 1 |
| 22 | 14 | PAHZZ | 5905-00-810-5641 | RC07GF330K | 81349 | RESISTOR, FXD, CMPSN | | EA | 2 |
| 22 | 15 | PAHZZ | 5905-00-811-4821 | RN65D1000F | 81349 | RESISTOR, FXD, FILM | | EA | 2 |
| 22 | 16 | XDHZZ | 5905-00-062-5037 | RN65D5620F | 81349 | RESISTOR, FXD, FILM | | EA | 1 |
| 22 | 17 | PAHZZ | 5905-00-088-2298 | RN65D1470F | 81349 | RESISTOR, FDX, FILM | | EA | 1 |
| 22 | 18 | PAHZZ | 5910-00-067-5697 | CM05E270J03 | 81349 | CAPACITOR, FXD, MICA | | EA | 1 |
| 22 | 19 | PAHZZ | 5910-00-984-5619 | CM05C120K03 | 81349 | CAPACITOR, FXD, MICA | | EA | 1 |
| 22 | 20 | PAHZZ | 5905-00-752-3157 | RC07GF273K | 81349 | RESISTOR, FXD, CMPSN | | EA | 1 |
| 22 | 21 | XDHZZ | | SMC508339 | 80063 | COIL, RADIO, FREQ | | EA | 5 |
| 22 | 22 | PAHZZ | 5961-00-556-2091 | 1N270 | 81349 | SEMICONDUCTOR, DIODE | | EA | 2 |
| 22 | 23 | PAHZZ | 5905-00-135-6046 | RC07GF681K | 81349 | RESISTOR, FXD, CMPSN | | EA | 1 |
| 22 | 24 | XDHZZ | | SMD508415 | 80063 | CAPACITOR, FXD, CER | | EA | 2 |
| 22 | 25 | PAHZZ | 5905-00-726-5344 | RC07GF153K | 81349 | RESISTOR, FXD, CMPSN | | EA | 1 |
| 22 | 26 | XDHZZ | | SMD508435-1 | 81349 | RESISTOR, FXD, CMPSN | | EA | 1 |
| 22 | 27 | XDHZZ | | SMC508430 | 80063 | CAPACITOR, VARIABLE | | EA | 1 |
| 22 | 28 | XDHZZ | | SMD508442-3 | 80063 | RESISTOR, VARIABLE | | EA | 1 |
| 22 | 29 | PAHZZ | 5905-00-683-2242 | RC07GF471J | 81349 | RESISTOR, FXD, CMPSN | | EA | 1 |
| 22 | 30 | PAHZZ | 5905-00-755-0795 | RC07GF392K | 81349 | RESISTOR, FXD, CMPSN | | EA | 1 |
| 22 | 31 | PAHZZ | 5905-00-686-3798 | RC07GF272J | 81349 | RESISTOR, FXD, CMPSN | | EA | 1 |
| 22 | 32 | XDHZZ | | 1N830A | 81349 | SEMICONDUCTOR, DIODE | | EA | 1 |
| 22 | 33 | XDHZZ | | SMB508338 | 80063 | SCREW, MACHINE | | EA | 4 |
| 22 | 34 | PAHZZ | 5310-00-933-8118 | MS35338-78 | 96906 | WASHER, SPLIT | | EA | 4 |
| 22 | 35 | PAHZZ | 5310-00-068-9282 | SOS440-6 | 46384 | NUT, PLAIN, CLINCH | | EA | 4 |
| 22 | 36 | XDHZZ | | SMB508346 | 80063 | SLEEVE, RETAINING | | EA | 4 |
| 22 | 37 | XDHZZ | | SMD508384 | 80063 | COVER, BOARD | | EA | 1 |
| 22 | 38 | XDHZZ | | SMD508439 | 80063 | PLATE, MOUNTING | | EA | 1 |

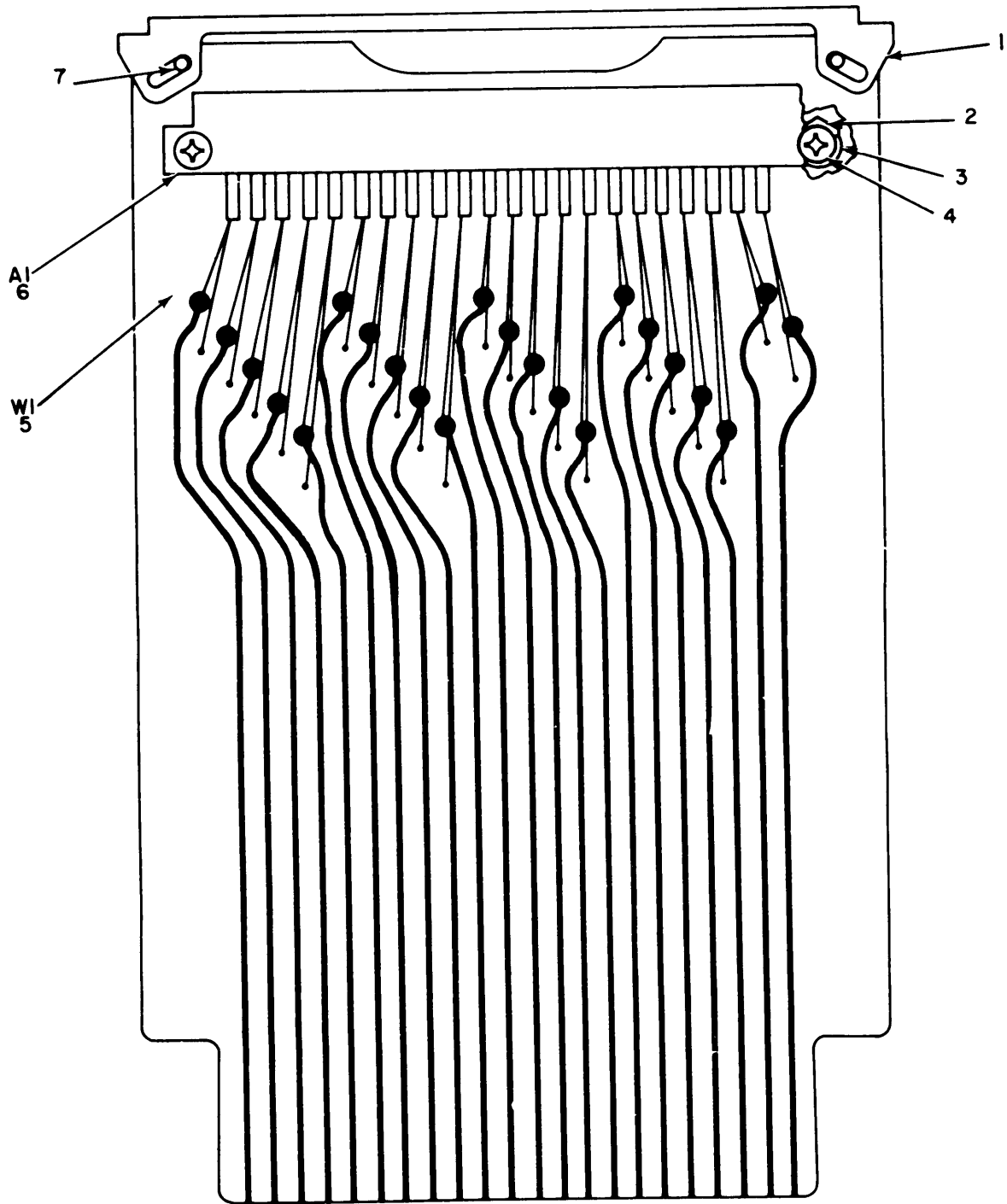

NOTE: FOR COMPLETE REFERENCE DESIGNATION
PREFIX WITH A2A15

EL5EL025

Figure 23. Test Set, Electronic Circuit Plug-In Unit AN/ARM-87, Board Extender.

| SECTION II | | | | | | TM11-6625-467-24P | | |
|--------------|------|-------|------------------|-----------|-------------|-----------------------|------|---|
| (1) | (2) | (3) | (4) | (5) | (6) | (7) | (8) | |
| ILLUSTRATION | | | | | | | | |
| (A) | (B) | | | | | | | |
| FIG | ITEM | SMR | NATIONAL | PART | DESCRIPTION | | QTY | |
| NO | NO | CODE | STOCK | NUMBER | FSCM | USABLE ON CODE | INC | |
| | | | NUMBER | | | | IN | |
| | | | | | | | UNIT | |
| 23 | 1 | XDHZZ | | SMD508399 | 80063 | HANDLE, BOARD | EA | 1 |
| 23 | 2 | XDHZZ | | SMC508321 | 80063 | NUT, PLAIN, HEXAGON | EA | 2 |
| 23 | 3 | XDHZZ | | SMB508554 | 80063 | WASHER, FLAT | EA | 2 |
| 23 | 4 | PAHZZ | 5305-00-054-5642 | MS51957-8 | 96906 | SCREW, MACHINE | EA | 2 |
| 23 | 5 | XDHZZ | | SMD508501 | 80063 | PW BOARD | EA | 1 |
| 23 | 6 | XDHZZ | | SMC508504 | 80063 | CONNECTOR, RCPT, ELEC | EA | 1 |
| 23 | 7 | XDHZZ | | SMC508318 | 80063 | PIN, STRAIGHT, HDLS | EA | 2 |

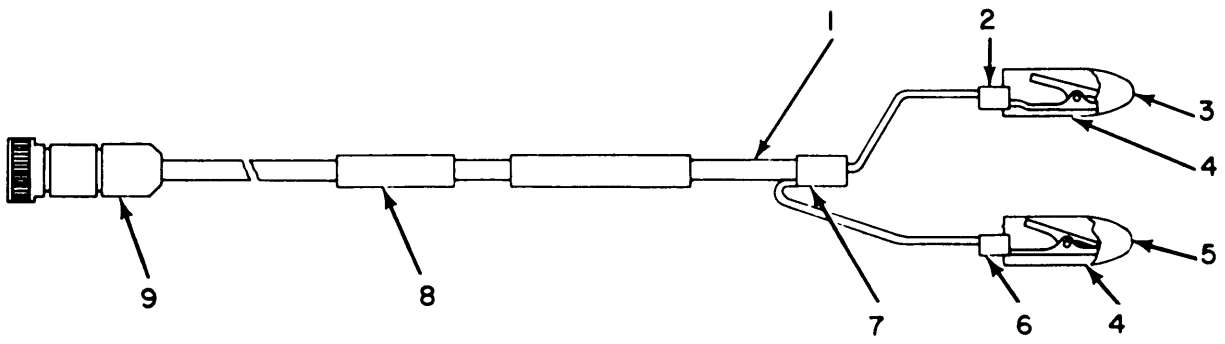

CX-1143/ARM87

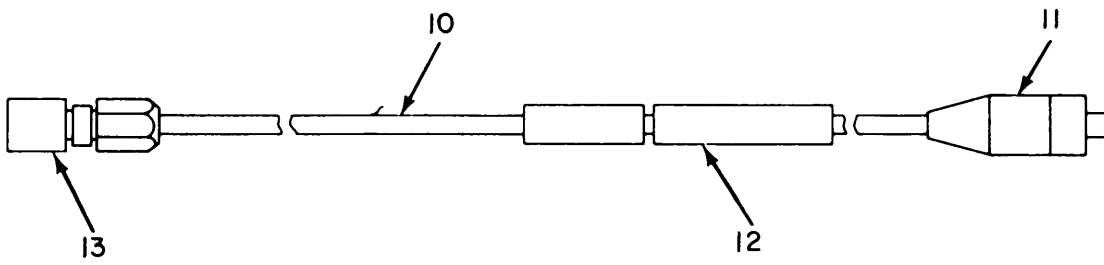

CG-3156/U

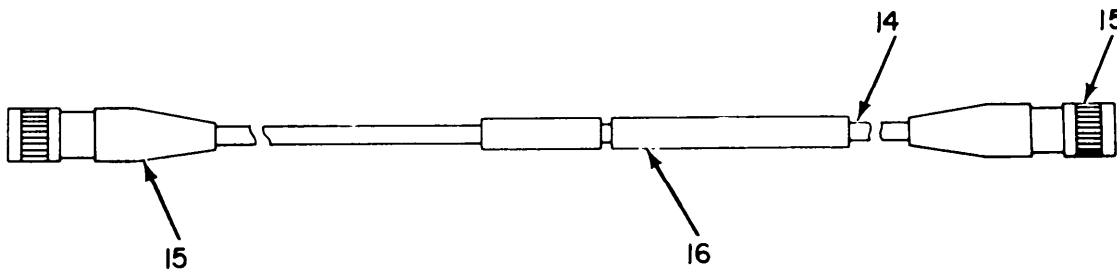

CG-3157/U
(10 IN), (6 IN)

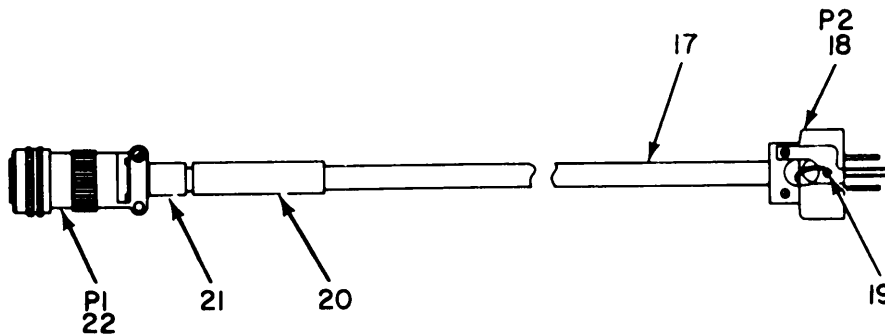

CX-1114/ARM87

EL5EL026

Figure 24. Cable Assemblies.

| SECTION II | | TM11-6625-467-24P | | | | | | |
|---------------------------|------|-------------------|------------------|---------------|-------------|----------------|------|--|
| (1) | (2) | (3) | (4) | (5) | (6) | (7) | (8) | |
| ILLUSTRATION | | | | | DESCRIPTION | USABLE ON CODE | QTY | |
| (A) | (B) | NATIONAL | (B) | | | | INC | |
| FIG | ITEM | STOCK | (B) | | | | IN | |
| NO | NO | NUMBER | NUMBER | FSCM | | | UNIT | |
| GROUP 01 CABLE ASSEMBLIES | | | | | | | | |
| 24 | 1 | XDHZZ | | RG196A/U | 80058 | | FT V | |
| 24 | 2 | XDHZZ | | SME508308-2 | 80063 | | FT V | |
| 24 | 3 | XDHZZ | | SMB508330-2 | 80063 | | EA 1 | |
| 24 | 4 | XDHZZ | | SMB508473 | 80063 | | EA 2 | |
| 24 | 5 | XDHZZ | | SMB508330-1 | 80063 | | EA 1 | |
| 24 | 6 | XDHZZ | | SME508308-1 | 80063 | | FT V | |
| 24 | 7 | XDHZZ | | SMC508348 | 80063 | | EA 1 | |
| 24 | 8 | XDHZZ | | SMB508399-3 | 80063 | | FT V | |
| 24 | 9 | XDHZZ | | SMC508345 | 80063 | | EA 1 | |
| 24 | 10 | XDHZZ | 6145-00-814-1209 | RG196A/U | 81349 | | FT V | |
| 24 | 11 | XDHZZ | | SMC508376 | 80063 | | EA 1 | |
| 24 | 12 | XDHZZ | | SMB5043993 | 80063 | | FT V | |
| 24 | 13 | XDHZZ | | SMC508345 | 80063 | | EA 1 | |
| 24 | 14 | XDHZZ | | RG196A/U | 80058 | | FT V | |
| 24 | 15 | XDHZZ | | SMD504826-1 | 80063 | | EA 2 | |
| 24 | 16 | XDHZZ | | SMB504399-3 | 80063 | | FT V | |
| 24 | 17 | XDHZZ | | SMB508332 | 80063 | | FT V | |
| 24 | 18 | XDHZZ | 5935-00-843-7362 | UP131M | 81349 | | EA 1 | |
| 24 | 19 | XDHZZ | | SMB508577 | 80063 | | EA 1 | |
| 24 | 20 | XDHZZ | | SMC508350-7 | 80063 | | FT V | |
| 24 | 21 | XDHZZ | | SMC508347-2 | 80063 | | FT V | |
| 24 | 22 | XDHZZ | 5935-00-925-7015 | MS3116J12-3SY | 96906 | | EA 1 | |

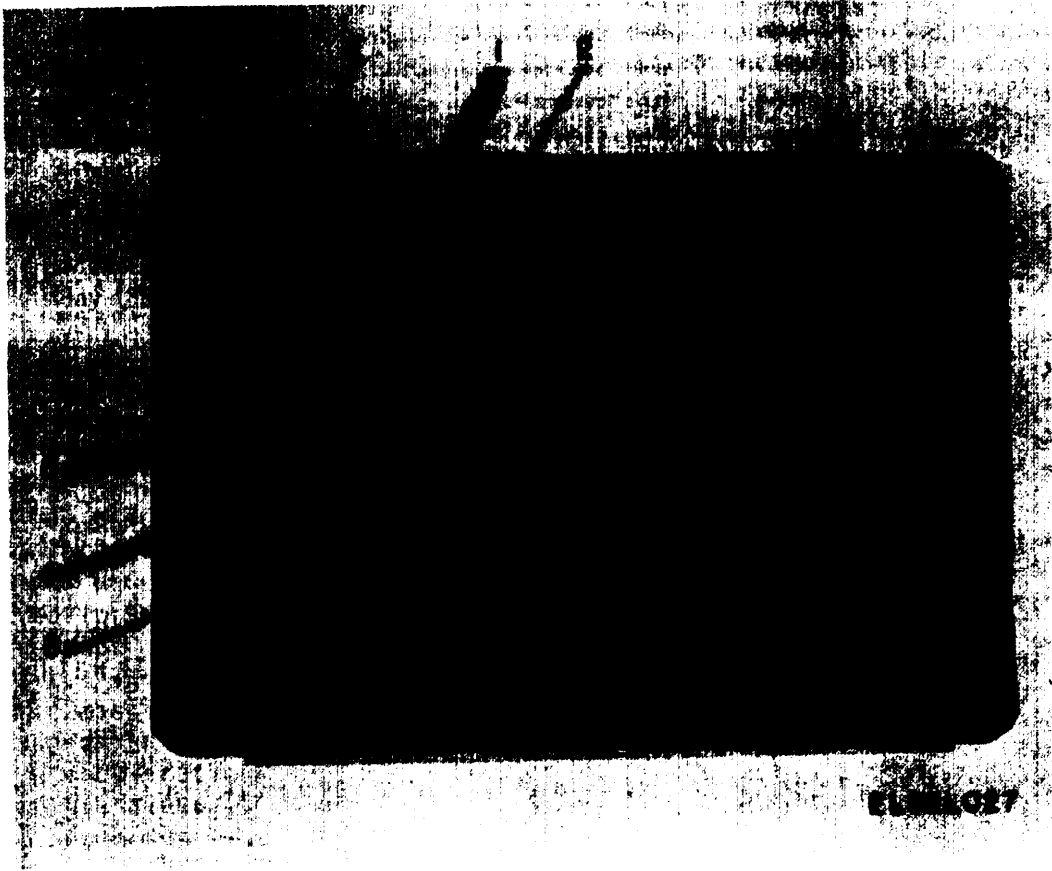
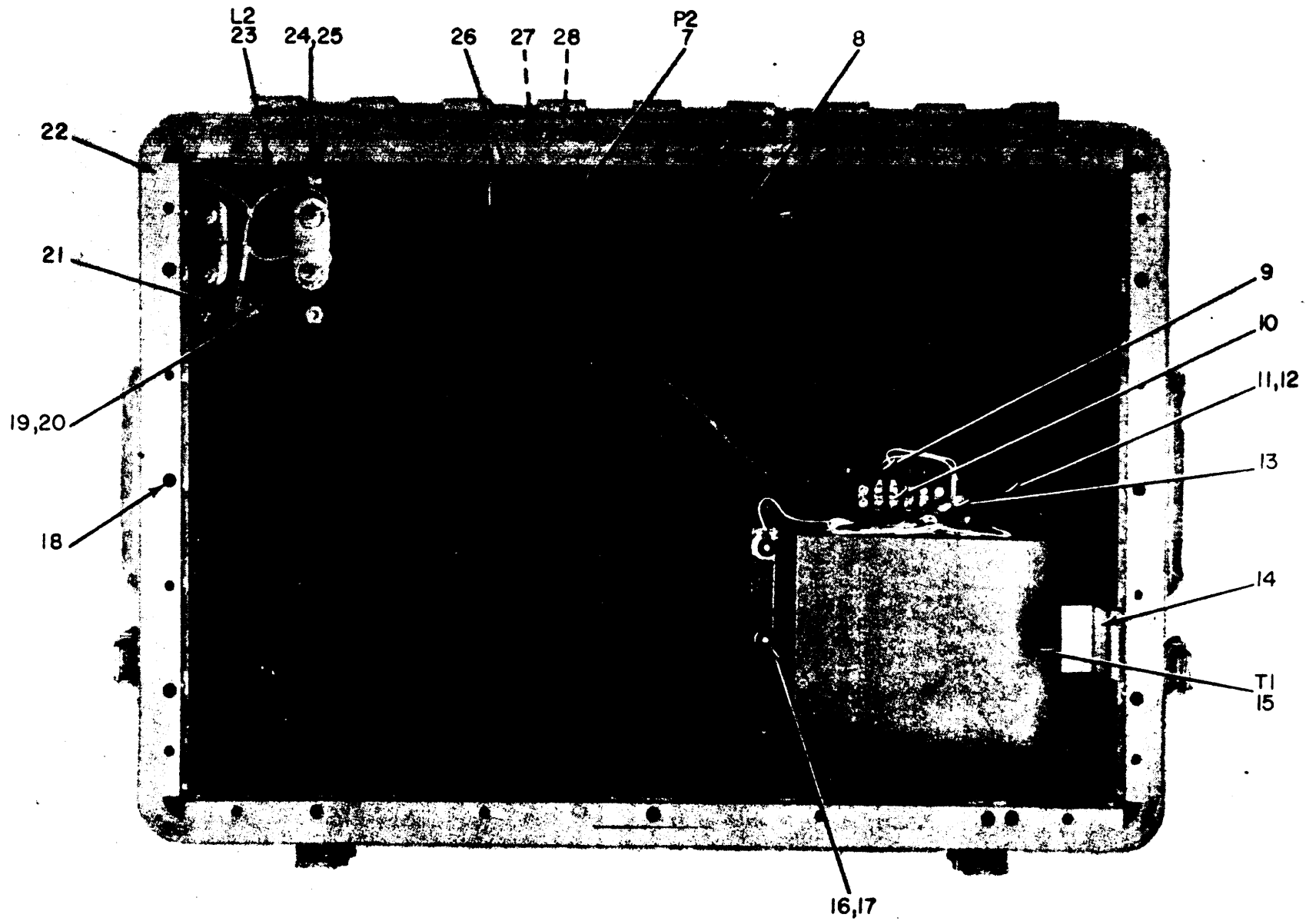
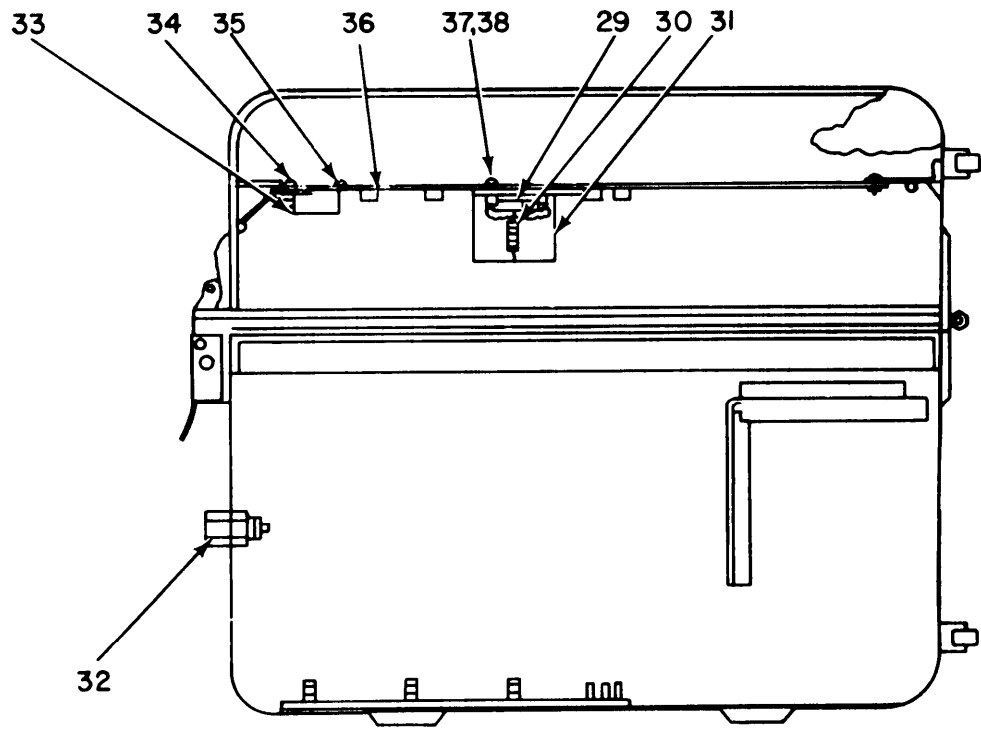

Figure 25. Case Assembly (Sheet 1 of 3).



EL5ELO28

Figure 25. Case Assembly (Sheet 2 of 3).



CASE MOUNTED PARTS

EL5EL029

Figure 25. Case Assembly (Sheet 3 of 3).

| SECTION II | | TM11-6625-467-24P | | | | | | |
|--------------|------|-------------------|------------------|---------------|------------------------|-----------------------|------|----|
| (1) | (2) | (3) | (4) | (5) | (6) | (7) | (8) | |
| ILLUSTRATION | | | | | DESCRIPTION | | QTY | |
| (A) | (B) | NATIONAL | PART | FSCM | | USABLE ON CODE | INC | |
| FIG | ITEM | STOCK | NUMBER | | | U/M | IN | |
| NO | NO | NUMBER | NUMBER | | GROUP 02 CASE ASSEMBLY | | UNIT | |
| NO | NO | SMR CODE | | | | | | |
| 25 | 1 | XDOZZ | | SMC508344-3 | 81349 | FUSE, CARTRIDGE | EA | 5 |
| 25 | 2 | PAHZZ | 5999-00-188-2219 | 4548 | 71400 | CLIP, ELECTRICAL | EA | 22 |
| 25 | 3 | PAOZZ | 6240-00-080-2012 | MS25237-15 | 96906 | LAMP, INCANDESCENT | EA | 1 |
| 25 | 4 | PAOZZ | 5920-00-280-3537 | F03A250V1AS | 81349 | FUSE, CARTIDGE | EA | 3 |
| 25 | 5 | XDOZZ | | SMC508344-1 | 81349 | FUSE, CARTRIDGE | EA | 3 |
| 25 | 6 | XDHZZ | | SMD508437 | 80063 | ATTENUATOR FIXED | EA | 1 |
| 25 | 7 | XDHZZ | | SMD508341-2 | 80063 | CONNECTOR, PLUG, ELEC | EA | 1 |
| 25 | 8 | XDHZZ | | SME508516 | 80063 | CABLE ASSYS | EA | 1 |
| 25 | 9 | PAHZZ | 5305-00-054-6654 | MS51957-30 | 96906 | SCREW, MACHINE | EA | 16 |
| 25 | 10 | XDHZZ | | SMC508313 | 80063 | WASHER, SPLIT | EA | 6 |
| 25 | 11 | PAHZZ | 5310-00-857-5547 | MS21044D06 | 96906 | NUT, FLAIN, HEXAGON | EA | 2 |
| 25 | 12 | PAHZZ | 5310-00-540-8119 | MS15795-305 | 96906 | WASHER, FLAT | EA | 2 |
| 25 | 13 | XDHZZ | | SMC508365-4 | 80063 | CLAMP, LOOP | EA | 1 |
| 25 | 14 | XDHZZ | | SMC508389 | 80063 | ADAPTER SWITCH | EA | 1 |
| 25 | 15 | XDHZZ | | SMD508362 | 80063 | TRANSFORMER, POWER | EA | 1 |
| 25 | 16 | XDHZZ | | SMC462455 | 80063 | NUT, SLFLNG, HEXAGON | EA | 6 |
| 25 | 17 | PAHZZ | 5310-00-880-5978 | MS15795-307 | 96906 | WASHER, FLAT | EA | 16 |
| 25 | 18 | XDHZZ | | SMB508301 | 80063 | SCREW, MACHINE | EA | 12 |
| 25 | 19 | XDHZZ | | 310-0046-00 | 79807 | WASHER, FLAT | EA | 1 |
| 25 | 20 | XDHZZ | | 68NM62 | 72962 | NUT, SLFLKG, HEXAGON | EA | 1 |
| 25 | 21 | PAHZZ | 5340-00-619-7754 | HP3N | 09922 | CLAMP, LOOP | EA | 1 |
| 25 | 22 | XDHZZ | | SMD508540 | 80063 | FLANGE ASSEMBLY | EA | 1 |
| 25 | 23 | XDHZZ | | SMD508522 | 80063 | REACTOR | EA | 1 |
| 25 | 24 | XDHZZ | | MS20365D1032A | 96906 | NUT, SLFLKG, HEXAGON | EA | 4 |
| 25 | 25 | PAHZZ | 5310-00-934-9761 | MS35649-64 | 96906 | NUT, FLAIN, HEXAGON | EA | 4 |
| 25 | 26 | XDHZZ | | SMD508341-3 | 80063 | ADAPTER, CABLE, CONN | EA | 1 |
| 25 | 27 | PAHZZ | 5305-00-054-5644 | MS51957-11 | 96906 | SCREW, MACHINE | EA | 4 |
| 25 | 28 | XDHZZ | | SMD508445 | 80063 | PLATE, IDENT | EA | 1 |
| 25 | 29 | XDHZZ | | SMD508403 | 80063 | BRACKET, MOUNTING | EA | 1 |
| 25 | 30 | XDHZZ | | SMC508374 | 80063 | SPRING, SLCL, EXT | EA | 2 |
| 25 | 31 | PAOZZ | 6625-00-902-7138 | SMD508408-2 | 80063 | COVER TST SET | EA | 1 |
| 25 | 32 | XDHZZ | | TA50A6 | 84971 | AIR PRESSURE EQL | EA | 1 |
| 25 | 33 | XDHZZ | | SMC508381 | 80063 | PAD | EA | 1 |
| 25 | 34 | XDHZZ | | SMB508388 | 80063 | SCREW, MACHINE | EA | 4 |
| 25 | 35 | PAHZZ | 5305-00-054-5649 | MS51957-15 | 96906 | SCREW, MACHINE | EA | 4 |
| 25 | 36 | XDHZZ | | SMC508378 | 80063 | CLAMP, BRACKET | EA | 1 |
| 25 | 37 | PAHZZ | 5310-00-857-5548 | MS21044D04 | 96906 | NUT, FLAIN, HEXAGON | EA | 6 |
| 25 | 38 | PAHZZ | 5305-00-770-2579 | MS51959-15 | 96906 | SCREW, MACHINE | EA | 2 |

NOTE: LATEST NATIONAL STOCK NUMBER AND PART NUMBER ASSIGNMENTS ARE INCLUDED AT END OF INDEX.

| STOCK NUMBER | FIGURE NO | ITEM NO | STOCK NUMBER | FIGURE NO | ITEM NO |
|------------------|--------------|------------|------------------|--------------|------------|
| 5905-00-001-7178 | 10 | 35 | 5905-00-195-5507 | 15 | 14 |
| 5310-00-011-1041 | 4 | 25 | 5905-00-195-6814 | 8 | 7 |
| 5310-00-011-1041 | 17 | 20 | 5905-00-195-6814 | 10 | 28 |
| 5961-00-022-5664 | 19 | 11 | 5905-00-221-5860 | 15 | 6 |
| 5955-00-043-1204 | 21 | 23 | 5905-00-225-9390 | 16 | 7 |
| 5910-00-043-2933 | 13 | 13 | 5961-00-226-3717 | 4 | 9 |
| 5910-00-051-4610 | 19 | 9 | 5905-00-229-2620 | 4 | 5 |
| 5910-00-051-4641 | 19 | 14 | 5310-00-240-6445 | 6 | 27 |
| 5910-00-051-4641 | 20 | 13 | 5905-00-249-4248 | 15 | 21 |
| 5910-00-051-4641 | 21 | 13 | 5905-00-257-2631 | 17 | 17 |
| 5305-00-054-5638 | 2 | 30 | 5310-00-271-4642 | 5 | 34 |
| 5305-00-054-5639 | 4 | 17 | 5905-00-279-1722 | 13 | 40 |
| 5305-00-054-5642 | 23 | 4 | 5905-00-279-1756 | 15 | 15 |
| 5305-00-054-5644 | 25 | 27 | 5905-00-279-2286 | 15 | 7 |
| 5305-00-054-5646 | 20 | 19 | 5905-00-279-2607 | 12 | 29 |
| 5305-00-054-5646 | 21 | 19 | 5905-00-279-2607 | 15 | 18 |
| 5305-00-054-5648 | 20 | 18 | 5905-00-279-2672 | 15 | 2 |
| 5305-00-054-5648 | 21 | 18 | 5920-00-280-3537 | 25 | 4 |
| 5305-00-054-5649 | 5 | 2 | 5920-00-280-4465 | 2 | 16 |
| 5305-00-054-5649 | 5 | 6 | 5310-00-281-9845 | 4 | 2 |
| 5305-00-054-5649 | 25 | 35 | 5310-00-281-9845 | 5 | 7 |
| 5305-00-054-5650 | 10 | 2 | 5905-00-299-2019 | 15 | 16 |
| 5305-00-054-5653 | 6 | 4 | 5905-00-299-2044 | 17 | 21 |
| 5305-00-054-6651 | 2 | 32 | 5340-00-368-4708 | 5 | 23 |
| 5305-00-054-6651 | 12 | 7 | 5910-00-433-5446 | 4 | 7 |
| 5305-00-054-6652 | 4 | 13 | 5910-00-460-0868 | 14 | 34 |
| 5305-00-054-6653 | 4 | 27 | 5910-00-460-0868 | 22 | 10 |
| 5305-00-054-6653 | 8 | 14 | 5961-00-468-3651 | 17 | 16 |
| 5305-00-054-6653 | 17 | 19 | 5910-00-495-0042 | 13 | 9 |
| 5305-00-054-6654 | 4 | 24 | 5910-00-495-0042 | 17 | 5 |
| 5305-00-054-6654 | 25 | 9 | 5310-00-540-8119 | 3 | 11 |
| 5305-00-054-6659 | 3 | 10 | 5310-00-540-8119 | 25 | 12 |
| 5305-00-059-3657 | 8 | 10 | 5910-00-543-0822 | 7 | 7 |
| 5910-00-060-1194 | 10 | 16 | 5310-00-543-2740 | 6 | 28 |
| 5910-00-060-1194 | 14 | 49 | 5905-00-552-5057 | 15 | 9 |
| 5910-00-060-1194 | 19 | 3 | 5905-00-552-5716 | 10 | 34 |
| 5905-00-060-2481 | 18 | 15 | 5905-00-552-5716 | 16 | 11 |
| 5905-00-060-2484 | 10 | 42 | 5961-00-556-2091 | 22 | 22 |
| 5905-00-062-0538 | 18 | 14 | 5961-00-577-6084 | 16 | 4 |
| 5310-00-062-0906 | 4 | 23 | 5905-00-577-7493 | 6 | 17 |
| 5905-00-062-5037 | 22 | 16 | 5910-00-578-1623 | 10 | 13 |
| 5905-00-062-5039 | 18 | 27 | 5961-00-579-4965 | 13 | 39 |
| 5905-00-063-8405 | 18 | 10 | 5961-00-583-0897 | 17 | 13 |
| 5905-00-064-0555 | 16 | 8 | 5961-00-615-0095 | 13 | 6 |
| 5910-00-067-5697 | 21 | 3 | 5961-00-615-0095 | 14 | 2 |
| 5910-00-067-5697 | 22 | 18 | 5930-00-615-3630 | 3 | 3 |
| 5310-00-068-9282 | 22 | 35 | 5355-00-616-9604 | 2 | 2 |
| 5905-00-069-3910 | 18 | 7 | 5910-00-617-4948 | 7 | 7 |
| 5950-00-070-7642 | 5 | 32 | 5340-00-619-7754 | 25 | 21 |
| 5305-00-071-1323 | 2 | 28 | 5930-00-655-1575 | 2 | 13 |
| 5325-00-074-3301 | 3 | 14 | 5905-00-682-1101 | 14 | 20 |
| 5950-00-075-9144 | 13 | 35 | 5905-00-682-4098 | 10 | 4 |
| 5905-00-079-4057 | 10 | 21 | 5905-00-682-4098 | 14 | 18 |
| 5910-00-079-9474 | 8 | 2 | 5905-00-682-4222 | 7 | 1 |
| 5961-00-081-4816 | 6 | 7 | 5905-00-683-2242 | 22 | 29 |
| 5910-00-081-8526 | 14 | 35 | 5905-00-683-7721 | 11 | 21 |
| 5910-00-082-4926 | 8 | 9 | 5905-00-683-7721 | 12 | 28 |
| 5905-00-087-6592 | 17 | 6 | 5905-00-686-3131 | 18 | 23 |
| 5910-00-088-0282 | 12 | 9 | 5905-00-686-3798 | 22 | 31 |
| 5910-00-088-0283 | 10 | 48 | 5905-00-686-4525 | 12 | 10 |
| 5910-00-088-0283 | 20 | 3 | 5905-00-686-4525 | 22 | 12 |
| 5905-00-088-2298 | 10 | 43 | 5905-00-686-4527 | 11 | 13 |
| 5905-00-088-2298 | 22 | 17 | 5905-00-686-4527 | 12 | 16 |
| 5905-00-088-3101 | 18 | 31 | 5905-00-686-4527 | 13 | 11 |
| 5905-00-088-3355 | 18 | 2 | 5905-00-686-4528 | 10 | 10 |
| 5950-00-089-3021 | 13 | 14 | 5905-00-686-4528 | 13 | 4 |
| 5905-00-106-1356 | 11 | 15 | | 11 | 22 |
| 5905-00-115-3560 | 11 | 25 | 5905-00-686-4529 | 14 | 40 |
| 5320-00-117-6826 | 8 | 23 | 5905-00-686-4529 | 20 | 7 |
| 5905-00-119-3503 | 13 | 24 | 5905-00-686-4529 | 21 | 7 |
| 5905-00-119-3504 | 11 | 4 | 5905-00-686-4530 | 13 | 36 |
| 5905-00-135-6046 | 12 | 38 | 5961-00-686-8578 | 12 | 37 |
| 5905-00-135-6046 | 14 | 41 | 5961-00-686-8578 | 14 | 30 |
| 5905-00-135-6046 | 22 | 23 | 5961-00-686-8578 | 19 | 4 |
| 6240-00-155-7836 | 2 | 5 | 5905-00-686-9997 | 12 | 17 |
| 6210-00-169-5157 | 2 | 14 | 5905-00-686-9998 | 14 | 9 |
| 5905-00-171-2005 | 17 | 11 | 5905-00-686-9998 | 22 | 6 |
| 5905-00-171-2009 | 10 | 24 | 5905-00-688-3475 | 18 | 35 |
| 5905-00-185-8518 | 16 | 3 | 5905-00-688-4447 | 10 | 15 |
| 5999-00-188-2219 | 25 | 2 | 5905-00-688-4447 | 11 | 9 |

| STOCK NUMBER | FIGURE NO | ITEM NO | STOCK NUMBER | FIGURE NO | ITEM NO |
|------------------|-----------|---------|------------------|-----------|---------|
| 5905-00-688-4447 | 13 | 5 | 5905-00-811-4821 | 22 | 15 |
| 5821-00-704-1602 | 4 | 21 | 5910-00-811-5081 | 10 | 3 |
| 5910-00-717-5853 | 12 | 12 | 5905-00-811-7912 | 10 | 7 |
| 5910-00-717-5853 | 13 | 29 | 5905-00-811-7912 | 14 | 11 |
| 5905-00-721-0552 | 10 | 46 | 5905-00-811-7912 | 19 | 15 |
| 5905-00-721-4124 | 6 | 15 | 5905-00-811-7912 | 20 | 9 |
| 5320-00-721-5244 | 10 | 20 | 5905-00-811-7912 | 21 | 9 |
| 5950-00-726-0166 | 14 | 27 | 5355-00-813-2078 | 2 | 11 |
| 5905-00-726-3807 | 12 | 13 | 5961-00-813-7283 | 15 | 19 |
| 5905-00-726-5340 | 14 | 12 | 5905-00-813-8640 | 11 | 20 |
| 5905-00-726-5340 | 19 | 22 | 6145-00-814-1209 | 24 | 10 |
| 5905-00-726-5340 | 22 | 13 | 5905-00-814-9680 | 8 | 8 |
| 5905-00-726-5344 | 11 | 30 | 5905-00-816-8554 | 11 | 28 |
| 5905-00-726-5344 | 13 | 15 | 5905-00-816-8554 | 12 | 4 |
| 5905-00-726-5344 | 22 | 25 | 5905-00-816-8554 | 13 | 26 |
| 5905-00-726-5345 | 11 | 24 | 5905-00-816-8554 | 14 | 38 |
| 5905-00-726-5345 | 18 | 29 | 5905-00-816-8554 | 19 | 10 |
| 5905-00-726-5346 | 11 | 34 | 5905-00-816-8554 | 20 | 20 |
| | | | 5905-00-816-8554 | 21 | 20 |
| 5905-00-726-5346 | 14 | 15 | 5940-00-817-4880 | 2 | 6 |
| 5905-00-726-6431 | 11 | 33 | 5905-00-825-2357 | 12 | 31 |
| 5905-00-726-6433 | 13 | 18 | 5905-00-825-2357 | 14 | 3 |
| 5905-00-726-6433 | 14 | 44 | 5905-00-825-2360 | 11 | 31 |
| 5905-00-726-6433 | 20 | 16 | 5905-00-825-2360 | 14 | 21 |
| 5905-00-726-6433 | 21 | 16 | 5340-00-840-0954 | 2 | 26 |
| 5905-00-726-6436 | 10 | 17 | 5910-00-842-2292 | 7 | 7 |
| 5905-00-726-6436 | 11 | 29 | 5961-00-842-6937 | 14 | 7 |
| 5905-00-726-6441 | 7 | 8 | 5905-00-843-2030 | 6 | 22 |
| 5905-00-726-6441 | 11 | 8 | 5935-00-843-7362 | 24 | 18 |
| 5905-00-726-6441 | 14 | 42 | 5961-00-845-3954 | 17 | 7 |
| 5905-00-726-6441 | 19 | 24 | 5961-00-847-5246 | 17 | 14 |
| 5905-00-726-6834 | 20 | 12 | 5961-00-852-7549 | 17 | 2 |
| 5905-00-726-6834 | 21 | 12 | 5905-00-855-6140 | 4 | 11 |
| 5905-00-726-6834 | 22 | 11 | 5905-00-855-7207 | 18 | 17 |
| 5905-00-726-6836 | 20 | 5 | 5905-00-856-7774 | 13 | 31 |
| 5905-00-726-6836 | 21 | 5 | 5310-00-857-5547 | 7 | 10 |
| 5305-00-727-8832 | 7 | 15 | 5310-00-857-5547 | 25 | 11 |
| 5961-00-728-3444 | 6 | 9 | 5310-00-857-5548 | 10 | 49 |
| 5961-00-728-5965 | 13 | 32 | 5310-00-857-5548 | 25 | 37 |
| 5905-00-732-3912 | 16 | 14 | 5910-00-880-6080 | 12 | 3 |
| 5961-00-752-0218 | 17 | 22 | 5910-00-880-6080 | 22 | 5 |
| 5905-00-752-3156 | 14 | 43 | 5905-00-892-1337 | 6 | 18 |
| 5905-00-752-3156 | 18 | 33 | 5905-00-892-6464 | 18 | 34 |
| 5905-00-752-3156 | 19 | 2 | 5905-00-892-6466 | 10 | 38 |
| 5905-00-752-3157 | 12 | 8 | 5905-00-892-6475 | 10 | 39 |
| 5905-00-752-3157 | 13 | 2 | 5905-00-892-6799 | 17 | 12 |
| 5905-00-752-3157 | 14 | 28 | 5905-00-892-7278 | 10 | 41 |
| 5905-00-752-3157 | 22 | 20 | 5905-00-892-7283 | 18 | 26 |
| 5905-00-752-3158 | 10 | 9 | 5950-00-892-8329 | 13 | 8 |
| 5905-00-752-3335 | 14 | 17 | 5961-00-893-9563 | 7 | 12 |
| 5905-00-752-3335 | 19 | 8 | 5905-00-894-6811 | 10 | 25 |
| | | | 5905-00-894-6811 | 11 | 19 |
| | | | 5961-00-899-9347 | 4 | 10 |
| | | | 5910-00-905-2962 | 12 | 23 |
| | | | 6625-00-906-7958 | 9 | 10 |
| | | | 5935-00-912-8997 | 2 | 12 |
| | | | 5950-00-914-7724 | 14 | 39 |
| 5905-00-752-3340 | 12 | 22 | 5905-00-914-8633 | 8 | 3 |
| 5905-00-752-3340 | 14 | 14 | 5935-00-925-7015 | 24 | 22 |
| 5905-00-752-3340 | 18 | 36 | 5310-00-933-8118 | 6 | 5 |
| 5905-00-752-3340 | 19 | 5 | 5310-00-933-8118 | 19 | 31 |
| 5320-00-753-3942 | 19 | 17 | 5310-00-933-8118 | 20 | 25 |
| 5905-00-755-0795 | 7 | 4 | 5310-00-933-8118 | 21 | 25 |
| 5905-00-755-0795 | 12 | 30 | 5310-00-933-8118 | 22 | 34 |
| 5905-00-755-0795 | 13 | 16 | 5310-00-934-9761 | 17 | 18 |
| 5905-00-755-0795 | 22 | 30 | 5961-00-949-1432 | 11 | 36 |
| 5905-00-755-0797 | 19 | 16 | 5961-00-949-1432 | 12 | 35 |
| 5905-00-761-1901 | 10 | 36 | | 13 | 23 |
| 5305-00-763-7822 | 8 | 6 | 5905-00-950-4378 | 10 | 37 |
| 5305-00-763-7827 | 5 | 36 | 5905-00-950-4378 | 15 | 17 |
| 5305-00-770-2579 | 25 | 38 | 5905-00-950-4378 | 17 | 23 |
| 5305-00-770-2580 | 2 | 8 | 5905-00-950-6790 | 18 | 39 |
| 5950-00-771-2089 | 13 | 10 | 5905-00-950-6793 | 10 | 45 |
| 5310-00-782-1349 | 5 | 3 | 5905-00-951-4045 | 18 | 16 |
| 5905-00-810-5641 | 22 | 14 | 5905-00-951-5713 | 11 | 26 |
| 5905-00-811-0673 | 10 | 32 | 5905-00-951-5754 | 18 | 30 |
| 5905-00-811-0673 | 11 | 6 | 5905-00-951-6735 | 17 | 10 |
| 5905-00-811-0673 | 20 | 8 | 5905-00-952-4716 | 12 | 32 |
| 5905-00-811-0673 | 21 | 8 | 5910-00-952-6432 | 5 | 27 |
| 5905-00-811-0674 | 14 | 19 | 5905-00-952-9428 | 18 | 9 |

| STOCK NUMBER | FIGURE NO | ITEM NO | STOCK NUMBER | FIGURE NO | ITEM NO |
|------------------|-----------|---------|------------------|-----------|---------|
| 5905-00-952-9435 | 10 | 26 | 5905-00-969-5857 | 12 | 21 |
| 5905-00-952-9435 | 18 | 20 | 5910-00-984-5619 | 22 | 19 |
| 5910-00-954-1769 | 10 | 8 | 5905-00-984-7684 | 12 | 34 |
| 5910-00-954-1769 | 14 | 53 | 5905-00-984-7709 | 18 | 32 |
| 5910-00-954-1769 | 19 | 27 | 5905-00-989-5574 | 10 | 40 |
| 5910-00-954-1772 | 19 | 13 | 5905-00-989-5574 | 16 | 13 |
| 5910-00-954-5502 | 20 | 24 | 5905-00-989-5580 | 11 | 27 |
| 5910-00-954-5502 | 21 | 24 | 5905-00-989-5580 | 13 | 19 |
| 5910-00-954-7368 | 14 | 23 | 5905-00-989-5580 | 18 | 8 |
| 5910-00-957-8582 | 11 | 10 | 5905-00-990-2249 | 17 | 4 |
| 5910-00-957-8582 | 12 | 41 | 5905-00-990-3029 | 10 | 31 |
| 5910-00-957-8582 | 13 | 27 | 5905-00-993-1353 | 18 | 37 |
| 5910-00-957-8582 | 20 | 6 | 5905-00-993-1358 | 10 | 27 |
| 5910-00-957-8582 | 21 | 6 | 5905-00-993-1362 | 18 | 12 |
| 5905-00-958-3498 | 12 | 26 | 5905-00-993-1365 | 18 | 21 |
| 5905-00-958-3498 | 13 | 17 | 5905-00-993-2263 | 18 | 22 |
| 5905-00-958-3498 | 18 | 6 | 5905-00-993-2264 | 10 | 29 |
| 5905-00-964-2219 | 10 | 47 | 5905-00-993-6012 | 10 | 30 |
| 5905-00-964-2376 | 10 | 22 | 5905-00-993-6012 | 18 | 25 |
| 5905-00-964-2376 | 18 | 38 | 5905-00-993-6975 | 18 | 13 |

| PART NUMBER | FSCM | FIG NO | ITEM NO | PART NUMBER | FSCM | FIG NO | ITEM NO |
|-----------------|-------|--------|---------|----------------|-------|--------|---------|
| AN936A10B | 88044 | 3 | 5 | CM06F821J03 | 81349 | 13 | 13 |
| AN936A416B | 88044 | 6 | 10 | CM07F203J03 | 81349 | 12 | 36 |
| CC20CH040D | 81349 | 7 | 7 | CM07F622J03 | 81349 | 13 | 29 |
| CC20CH050D | 81349 | 7 | 7 | CM07F822J03 | 81349 | 12 | 43 |
| CC20CK010D | 81349 | 7 | 7 | CRS13G105LK | 81349 | 17 | 5 |
| CC20CK020D | 81349 | 7 | 7 | CR18AU3-975MC | 81349 | 19 | 19 |
| CE13C120P | 81349 | 8 | 1 | CR18AU5-925MC | 81349 | 19 | 25 |
| CE13C221G | 81349 | 8 | 2 | CR25AU | 81349 | 10 | 19 |
| CG-3156/U(10IN) | 80058 | 1 | 4 | CR56AU | 81349 | 21 | 23 |
| CG3157/U-10IN | 80058 | 1 | 5 | CS13BE106M | 81349 | 4 | 7 |
| CG3157/U-6IN | 80058 | 1 | 7 | CS13BF476M | 81349 | 12 | 23 |
| CL65CJ820MP3 | 80063 | 17 | 25 | CS13BF685K | 81349 | 8 | 9 |
| CL65CJ820MP3 | 81349 | 14 | 22 | CS13B226M | 81349 | 16 | 6 |
| CL65CL560MP3 | 81349 | 17 | 15 | CS13G105KL | 81349 | 13 | 9 |
| CM05C120K03 | 81349 | 22 | 19 | | | | |
| CM05E270J03 | 81349 | 21 | 3 | CV11C450 | 81349 | 10 | 13 |
| CM05E270J03 | 81349 | 22 | 18 | CX11144/ARM-87 | 80058 | 1 | 6 |
| CM05E390J03 | 81349 | 10 | 48 | CX1143/ARM-87 | 80058 | 1 | 3 |
| CM05E390J03 | 81349 | 20 | 3 | DCMF37S | 71468 | 2 | 29 |
| CM05E470J03 | 81349 | 19 | 13 | F02A250V1AS | 81349 | 2 | 16 |
| CM05E680J03 | 81349 | 19 | 9 | F03A250V1AS | 81349 | 25 | 4 |
| CM05E820J03 | 81349 | 14 | 25 | HP3N | 09922 | 25 | 21 |
| CM05E820J03 | 81349 | 22 | 9 | MS122079 | 96906 | 5 | 23 |
| CM05F101J03 | 81349 | 14 | 34 | MS15795-304 | 96906 | 5 | 3 |
| CM05F101J03 | 81349 | 22 | 10 | MS15795-305 | 96906 | 3 | 11 |
| CM05F121J03 | 81349 | 10 | 3 | MS15795-305 | 96906 | 25 | 12 |
| CM05F131J03 | 81349 | 20 | 24 | MS15795-307 | 96906 | 25 | 17 |
| CM05F131J03 | 81349 | 21 | 24 | MS16535-52 | 96906 | 19 | 17 |
| CM05F151J03 | 81349 | 10 | 8 | MS16535-77 | 96906 | 10 | 20 |
| CM05F151J03 | 81349 | 14 | 53 | MS20365D1032A | 96906 | 25 | 24 |
| CM05F151J03 | 81349 | 19 | 27 | MS20365D440A | 96906 | 5 | 7 |
| CM05F181J03 | 81349 | 12 | 9 | MS20365D632A | 96906 | 5 | 24 |
| CM05F221J03 | 81349 | 19 | 6 | MS20470AD4-4 | 96906 | 8 | 23 |
| CM05F241J03 | 81349 | 14 | 23 | MS21044D04 | 96906 | 10 | 49 |
| CM05F391J03 | 81349 | 14 | 35 | MS21044D04 | 96906 | 25 | 37 |
| CM05F910G03 | 81349 | 14 | 36 | MS21044D06 | 96906 | 7 | 10 |
| CM06F102J03 | 81349 | 10 | 16 | MS21044D06 | 96906 | 25 | 11 |
| CM06F102J03 | 81349 | 14 | 49 | MS21266-2N | 96906 | 3 | 14 |
| CM06F102J03 | 81349 | 19 | 3 | MS25237-15 | 96906 | 25 | 3 |
| CM06F122J03 | 81349 | 12 | 3 | MS25237-327 | 96906 | 2 | 5 |
| CM06F122J03 | 81349 | 22 | 5 | MS3112E12-3PY | 96906 | 2 | 12 |
| CM06F182J03 | 81349 | 12 | 12 | MS3116J12-3SY | 96906 | 24 | 22 |
| CM06F182J03 | 81349 | 13 | 29 | MS35059-22 | 96906 | 2 | 13 |
| CM06F222J03 | 81349 | 11 | 10 | MS35333-74 | 96906 | 6 | 28 |
| CM06F222J03 | 81349 | 12 | 41 | MS35338-78 | 96906 | 6 | 5 |
| CM06F222J03 | 81349 | 13 | 28 | MS35338-78 | 96906 | 19 | 31 |
| CM06F222J03 | 81349 | 20 | 6 | MS35338-78 | 96906 | 20 | 25 |
| CM06F222J03 | 81349 | 21 | 6 | MS35338-78 | 96906 | 21 | 25 |
| CM06F332J03 | 81349 | 11 | 11 | MS35338-78 | 96906 | 22 | 34 |
| CM06F332J03 | 81349 | 13 | 22 | MS35338-79 | 96906 | 4 | 25 |
| CM06F472J03 | 81349 | 19 | 14 | MS35338-79 | 96906 | 17 | 20 |
| CM06F472J03 | 81349 | 20 | 13 | MS35649-264 | 96906 | 17 | 18 |
| CM06F472J03 | 81349 | 21 | 13 | MS35649-44 | 96906 | 5 | 34 |
| CM06F561J03 | 81349 | 5 | 27 | MS35649-64 | 96906 | 25 | 25 |
| CM06F681J03 | 81349 | 14 | 52 | MS39087-4 | 96906 | 2 | 26 |

| PART NUMBER | FSCM | FIG NO | ITEM NO | PART NUMBER | FSCM | FIG NO | ITEM NO |
|--------------|-------|--------|---------|-------------|-------|--------|---------|
| MS50957-5 | 96906 | 2 | 20 | RC07GF183K | 81349 | 13 | 25 |
| MS50957-7 | 96906 | 5 | 10 | RC07GF184K | 81349 | 11 | 33 |
| MS51057-29 | 96906 | 6 | 19 | RC07GF185K | 81349 | 12 | 24 |
| MS51957-11 | 96906 | 25 | 27 | RC07GF221K | 81349 | 11 | 31 |
| MS51957-12 | 96906 | 20 | 19 | RC07GF221K | 81349 | 14 | 21 |
| MS51957-12 | 96906 | 21 | 19 | RC07GF222K | 81349 | 13 | 18 |
| MS51957-14 | 96906 | 20 | 18 | RC07GF222K | 81349 | 14 | 44 |
| MS51957-14 | 96906 | 21 | 18 | RC07GF222K | 81349 | 20 | 16 |
| MS51957-15 | 96906 | 5 | 2 | RC07GF222K | 81349 | 21 | 16 |
| MS51957-15 | 96906 | 5 | 6 | RC07GF223K | 81349 | 14 | 43 |
| MS51957-15 | 96906 | 25 | 35 | RC07GF223K | 81349 | 18 | 33 |
| MS51957-16 | 96906 | 10 | 2 | RC07GF223K | 81349 | 19 | 2 |
| MS51957-19 | 96906 | 6 | 4 | RC07GF224K | 81349 | 14 | 18 |
| MS51957-27 | 96906 | 2 | 32 | RC07GF271J | 81349 | 13 | 24 |
| MS51957-27 | 96906 | 12 | 7 | RC07GF271K | 81349 | 12 | 10 |
| MS51957-28 | 96906 | 4 | 13 | RC07GF271K | 81349 | 22 | 12 |
| MS51957-29 | 96906 | 4 | 27 | RC07GF272J | 81349 | 22 | 31 |
| MS51957-29 | 96906 | 8 | 14 | RC07GF272K | 81349 | 11 | 13 |
| MS51957-29 | 96906 | 17 | 19 | RC07GF272K | 81349 | 12 | 16 |
| MS51957-30 | 96906 | 6 | 24 | RC07GF272K | 81349 | 13 | 11 |
| MS51957-30 | 96906 | 25 | 9 | RC07GF273J | 81349 | 11 | 4 |
| MS51957-35 | 96906 | 3 | 10 | RC07GF273K | 81349 | 12 | 8 |
| MS51957-4 | 96906 | 2 | 30 | RC07GF273K | 81349 | 13 | 2 |
| MS51957-5 | 96906 | 4 | 17 | RC07GF273K | 81349 | 14 | 28 |
| MS51957-8 | 96906 | 23 | 4 | RC07GF273K | 81349 | 22 | 20 |
| MS51958-61 | 96906 | 8 | 10 | RC07GF330K | 81349 | 22 | 14 |
| MS51959-14 | 96906 | 8 | 6 | RC07GF332K | 81349 | 10 | 10 |
| MS51959-15 | 96906 | 25 | 38 | RC07GF332K | 81349 | 13 | 4 |
| MS51959-16 | 96906 | 2 | 8 | RC07GF333K | 81349 | 10 | 17 |
| MS51959-18 | 96906 | 5 | 36 | RC07GF333K | 81349 | 11 | 29 |
| MS51959-29 | 96906 | 7 | 15 | RC07GF334J | 81349 | 18 | 23 |
| MS51960-6 | 96906 | 5 | 31 | RC07GF391K | 81349 | 14 | 19 |
| MS51960-66 | 96906 | 2 | 28 | RC07GF392J | 81349 | 10 | 4 |
| MS75052-7 | 96906 | 14 | 27 | RC07GF392J | 81349 | 14 | 20 |
| MS75053-2 | 96906 | 13 | 8 | RC07GF392K | 81349 | 7 | 4 |
| MS75053-4 | 96906 | 14 | 39 | RC07GF392K | 81349 | 12 | 30 |
| MS75054-5 | 96906 | 13 | 10 | RC07GF392K | 81349 | 13 | 16 |
| MS90538-12 | 96906 | 13 | 35 | RC07GF392K | 81349 | 22 | 30 |
| MS90541-04 | 96906 | 5 | 32 | RC07GF393K | 81349 | 7 | 1 |
| MS91189-12 | 96906 | 14 | 51 | RC07GF470K | 81349 | 10 | 7 |
| MS91528-0D1B | 96906 | 2 | 11 | RC07GF470K | 81349 | 14 | 11 |
| MS91528-1P2B | 96906 | 2 | 2 | RC07GF470K | 81349 | 19 | 15 |
| RC07GF101J | 81349 | 11 | 21 | RC07GF470K | 81349 | 20 | 9 |
| RC07GF101J | 81349 | 12 | 28 | RC07GF470K | 81349 | 21 | 9 |
| RC07GF101K | 81349 | 14 | 12 | RC07GF471J | 81349 | 22 | 29 |
| RC07GF101K | 81349 | 19 | 22 | RC07GF472J | 81349 | 14 | 9 |
| RC07GF101K | 81349 | 22 | 13 | RC07GF472J | 81349 | 22 | 6 |
| | | | | RC07GF472K | 81349 | 12 | 22 |
| | | | | RC07GF472K | 81349 | 14 | 14 |
| | | | | RC07GF472K | 81349 | 18 | 36 |
| | | | | RC07GF472K | 81349 | 19 | 5 |
| | | | | RC07GF473K | 81349 | 10 | 15 |
| | | | | RC07GF473K | 81349 | 11 | 9 |
| RC07GF103K | 81349 | 11 | 28 | RC07GF473K | 81349 | 13 | 5 |
| RC07GF103K | 81349 | 12 | 4 | RC07GF474K | 81349 | 18 | 35 |
| RC07GF103K | 81349 | 13 | 26 | RC07GF560K | 81349 | 19 | 16 |
| RC07GF103K | 81349 | 14 | 38 | RC07GF561K | 81349 | 7 | 8 |
| RC07GF103K | 81349 | 19 | 10 | RC07GF561K | 81349 | 11 | 8 |
| RC07GF103K | 81349 | 20 | 20 | RC07GF561K | 81349 | 14 | 42 |
| RC07GF103K | 81349 | 21 | 20 | RC07GF561K | 81349 | 19 | 24 |
| RC07GF104K | 81349 | 13 | 36 | RC07GF562K | 81349 | 20 | 12 |
| RC07GF105K | 81349 | 10 | 46 | RC07GF562K | 81349 | 21 | 12 |
| RC07GF122K | 81349 | 14 | 17 | RC07GF562K | 81349 | 22 | 11 |
| RC07GF122K | 81349 | 19 | 8 | RC07GF563K | 81349 | 12 | 31 |
| RC07GF123K | 81349 | 11 | 22 | RC07GF563K | 81349 | 14 | 3 |
| RC07GF123K | 81349 | 14 | 40 | RC07GF680K | 81349 | 20 | 5 |
| RC07GF123K | 81349 | 20 | 7 | RC07GF680K | 81349 | 21 | 5 |
| RC07GF123K | 81349 | 21 | 7 | RC07GF681K | 81349 | 12 | 38 |
| RC07GF124K | 81349 | 11 | 37 | RC07GF681K | 81349 | 14 | 41 |
| RC07GF152K | 81349 | 11 | 15 | RC07GF681K | 81349 | 22 | 23 |
| RC07GF152K | 81349 | 12 | 25 | RC07GF682J | 81349 | 12 | 17 |
| RC07GF153K | 81349 | 11 | 30 | RC07GF682K | 81349 | 10 | 32 |
| RC07GF153K | 81349 | 13 | 15 | RC07GF682K | 81349 | 11 | 6 |
| RC07GF153K | 81349 | 22 | 25 | RC07GF682K | 81349 | 20 | 8 |
| RC07GF154K | 81349 | 11 | 24 | RC07GF682K | 81349 | 21 | 8 |
| RC07GF154K | 81349 | 18 | 29 | | | | |
| RC07GF182K | 81349 | 11 | 34 | | | | |
| | | | | RC07GF823K | 81349 | 10 | 9 |
| RC07GF182K | 81349 | 14 | 15 | RC07GF912J | 81349 | 12 | 13 |
| RC07GF183K | 81349 | 11 | 25 | RC20GF103K | 81349 | 16 | 3 |

| PART NUMBER | FSCM | FIG NO | ITEM NO | PART NUMBER | FSCM | FIG NO | ITEM NO |
|-------------|-------|--------|---------|--------------|------------|--------|---------|
| RC20GF151K | 81349 | 15 | 15 | RN65D623F | 81349 | 10 | 35 |
| RC20GF182K | 81349 | 15 | 2 | RN65D6811F | 81349 | 18 | 15 |
| RC20GF222K | 81349 | 10 | 24 | RN65D7501F | 81349 | 18 | 26 |
| RC20GF223K | 81349 | 4 | 5 | RN65D7502F | 81349 | 10 | 31 |
| RC20GF333K | 81349 | 15 | 21 | RN65D8252F | 81349 | 10 | 38 |
| RC20GF334K | 81349 | 15 | 6 | RN65D8253F | 81349 | 10 | 37 |
| RC20GF471K | 81349 | 17 | 11 | RN65D8253F | 81349 | 15 | 17 |
| RC20GF821K | 81349 | 17 | 17 | RN65D8253F | 81349 | 17 | 23 |
| RC32GF102K | 81349 | 13 | 41 | RN65D9092F | 81349 | 10 | 26 |
| RC32GF182K | 81349 | 15 | 9 | RN65D9092F | 81349 | 18 | 20 |
| RC32GF222K | 81349 | 17 | 21 | RN65D9311F | 81349 | 10 | 45 |
| RC32GF223K | 81349 | 15 | 16 | RN70B2374F | RN70B2374F | 81349 | 10 |
| RC32GF681K | 81349 | 12 | 29 | RN70B2374F | 81349 | 16 | 11 |
| RC32GF681K | 81349 | 15 | 18 | RN70B7503F | 81349 | 10 | 33 |
| RC42GF102K | 81349 | 8 | 7 | RN70B7503F | 81349 | 16 | 10 |
| RC42GF102K | 81349 | 10 | 28 | RN70D10R0F | 81349 | 16 | 14 |
| RC42GF104K | 81349 | 16 | 15 | RN70D5110F | 81349 | 17 | 4 |
| RC42GF122K | 81349 | 15 | 14 | | | | |
| RC42GF681K | 81349 | 15 | 20 | RV6NAYSL103B | 81649 | 6 | 14 |
| RC42GF821K | 81349 | 15 | 7 | RV6NAYSL252B | 81349 | 6 | 15 |
| RC42GF822K | 81349 | 15 | 10 | RV6NAYSL503B | 81349 | 6 | 12 |
| RE65GR499 | 81349 | 4 | 11 | RW31V390 | 81349 | 6 | 18 |
| RG196A/U | 80058 | 24 | 1 | RW31V562 | 81349 | 6 | 17 |
| RG196A/U | 80058 | 24 | 14 | RW31V821 | 81349 | 6 | 22 |
| RG196A/U | 81349 | 24 | 10 | RW67VR39 | 81349 | 8 | 3 |
| RIMT16M | 91663 | 5 | 28 | RW67V100 | 81349 | 8 | 8 |
| RM65D1782F | 81349 | 16 | 12 | RW69V151 | 81349 | 17 | 10 |
| RN60D1470F | 81349 | 18 | 7 | RW69V220 | 81349 | 17 | 12 |
| RN60D2151F | 81349 | 10 | 36 | RW69V3R9 | 81349 | 17 | 6 |
| RN60D3322F | 81349 | 12 | 34 | SMB438752 | 80063 | 6 | 23 |
| RN60D7503F | 81349 | 16 | 7 | SMB504399-3 | 580063 | 24 | 16 |
| RN65D1000F | 81349 | 22 | 15 | SMB5043993 | 80063 | 24 | 12 |
| RN65D1002F | 81349 | 16 | 8 | SMB504539 | 80063 | 8 | 4 |
| RN65D1004F | 81349 | 10 | 39 | SMB504565 | 80063 | 6 | 27 |
| RN65D1052F | 81349 | 18 | 30 | SMB504790 | 80063 | 17 | 27 |
| RN65D1101F | 81349 | 10 | 22 | SMB508301 | 80063 | 25 | 18 |
| RN65D1101F | 81349 | 18 | 38 | SMB508315 | 80063 | 6 | 25 |
| RN65D1211F | 81349 | 18 | 27 | SMB508325-1 | 80063 | 4 | 3 |
| RN65D1331F | 81349 | 18 | 39 | SMB508329 | 80063 | 2 | 4 |
| RN65D1333F | 80063 | 18 | 24 | SMB508330-1 | 80063 | 24 | 5 |
| RN65D1470F | 81349 | 10 | 43 | SMB508330-2 | 80063 | 24 | 3 |
| RN65D1470F | 81349 | 22 | 17 | SMB508332 | 80063 | 24 | 17 |
| RN65D1471F | 81349 | 10 | 30 | SMB508338 | 80063 | 19 | 30 |
| RN65D1471F | 81349 | 18 | 25 | SMB508338 | 80063 | 20 | 26 |
| RN65D1472F | 81349 | 18 | 17 | SMB508338 | 80063 | 21 | 26 |
| RN65D1541F | 81349 | 12 | 32 | SMB508338 | 80063 | 22 | 33 |
| RN65D1622F | 81349 | 18 | 32 | SMB508346 | 80063 | 19 | 29 |
| RN65D1623F | 81349 | 10 | 40 | SMB508346 | 80063 | 20 | 27 |
| RN65D1623F | 81349 | 16 | 13 | SMB508346 | 80063 | 22 | 36 |
| RN65D1781F | 81349 | 18 | 13 | SMB508349 | 80063 | 6 | 26 |
| RN65D1960F | 81349 | 18 | 2 | SMB508351 | 80063 | 4 | 18 |
| RN65D1962F | 81349 | 11 | 26 | SMB508351 | 96906 | 3 | 4 |
| RN65D2151F | 81349 | 18 | 10 | SMB508386 | 80063 | 6 | 3 |
| RN65D2371F | 81349 | 10 | 27 | SMB508388 | 80063 | 25 | 34 |
| RN65D2373F | 81349 | 18 | 34 | SMB508393 | 80063 | 5 | 9 |
| RN65D2601F | 81349 | 18 | 11 | SMB508399-3 | 80063 | 24 | 8 |
| RN65D2612F | 81349 | 10 | 42 | SMB508473 | 80063 | 24 | 4 |
| RN65D2870F | 81349 | 18 | 31 | SMB508541 | 80063 | 5 | 5 |
| RN65D2871F | 81349 | 18 | 21 | SMB508554 | 80063 | 23 | 3 |
| RN65D3011F | 81349 | 10 | 41 | SMB508559 | 80063 | 8 | 11 |
| RN65D3161F | 81349 | 18 | 12 | SMB508577 | 80063 | 24 | 19 |
| RN65D34R8F | 81349 | 18 | 9 | SMC462455 | 80063 | 25 | 16 |
| RN65D3832F | 81349 | 18 | 14 | SMC504064 | 80063 | 2 | 25 |
| RN65D4020F | 81349 | 10 | 29 | SMC504067 | 80063 | 2 | 18 |
| RN65D4021F | 81349 | 12 | 21 | SMC504133-3 | 80063 | 2 | 19 |
| RN65D4221F | 81349 | 18 | 22 | SMC504301 | 80063 | 2 | 23 |
| RN65D46R4F | 81349 | 18 | 37 | SMC504554-2 | 80063 | 2 | 9 |
| RN65D4641F | 81349 | 18 | 16 | SMC504554-2 | 80063 | 5 | 33 |
| RN65D51R1F | 81349 | 10 | 25 | SMC504562 | 80063 | 5 | 11 |
| RN65D51R1F | 81349 | 11 | 19 | SMC504585 | 80063 | 13 | 31 |
| RN65D51R1F | 81349 | 12 | 26 | SMC504617 | 80063 | 13 | 14 |
| RN65D51R1F | 81349 | 13 | 17 | SMC504699 | 80063 | 5 | 26 |
| RN65D51R1F | 8149 | 18 | 6 | SMC508303 | 80063 | 10 | 11 |
| RN65D5110F | 81349 | 11 | 27 | SMC508303 | 80063 | 11 | 35 |
| RN65D5110F | 81349 | 13 | 19 | SMC508303 | 80063 | 12 | 18 |
| RN65D5110F | 81349 | 18 | 8 | SMC508303 | 80063 | 13 | 20 |
| RN65D5111F | 81349 | 11 | 20 | SMC508303 | 80063 | 14 | 6 |
| RN65D5620F | 81349 | 22 | 16 | SMC508303 | 80063 | 15 | 4 |
| RN65D5621F | 81349 | 10 | 47 | SMC508303 | 80063 | 17 | 9 |
| RN65D61R9F | 81349 | 10 | 21 | SMC508303 | 80063 | 19 | 21 |

| PART NUMBER | FSCM | FIG NO | ITEM NO | PART NUMBER | FSCM | FIG NO | ITEM NO |
|-------------|-------|--------|---------|--------------|-------|--------|---------|
| SMC508303 | 80063 | 20 | 15 | SMC508425-1 | 80063 | 4 | 19 |
| SMC508303 | 80063 | 21 | 15 | SMC508425-2 | 80063 | 2 | 14 |
| SMC508303 | 80063 | 22 | 3 | SMC508430 | 80063 | 22 | 27 |
| SMC508304 | 80063 | 6 | 21 | SMC508432 | 80063 | 15 | 22 |
| SMC508306 | 80063 | 3 | 7 | SMC508463 | 80063 | 8 | 21 |
| SMC508309 | 80063 | 12 | 33 | SMC508467 | 80063 | 2 | 34 |
| SMC508313 | 80063 | 25 | 10 | SMC508498 | 80063 | 7 | 9 |
| SMC508314 | 80063 | 4 | 26 | SMC508499 | 80063 | 6 | 2 |
| SMC508316 | 80063 | 20 | 23 | SMC508504 | 80063 | 23 | 6 |
| SMC508317 | 80063 | 5 | 12 | SMC508508 | 80063 | 6 | 8 |
| SMC508318 | 80063 | 10 | 5 | SMC508509 | 80063 | 6 | 11 |
| SMC508318 | 80063 | 11 | 5 | SMC508537 | 80063 | 5 | 8 |
| SMC508318 | 80063 | 12 | 40 | SMC508562 | 80063 | 4 | 16 |
| SMC508318 | 80063 | 13 | 34 | SMD504017 | 80063 | 20 | 2 |
| SMC508318 | 80063 | 14 | 46 | SMD504017 | 80063 | 21 | 2 |
| SMC508318 | 80063 | 15 | 23 | SMD504037-1 | 80063 | 8 | 13 |
| SMC508318 | 80063 | 16 | 2 | SMD504123-3 | 80063 | 11 | 7 |
| SMC508318 | 80063 | 17 | 3 | SMD504272-4 | 80063 | 13 | 33 |
| SMC508318 | 80063 | 18 | 4 | SMD504321 | 80063 | 14 | 37 |
| SMC508318 | 80063 | 19 | 26 | SMD504366 | 80063 | 2 | 24 |
| SMC508318 | 80063 | 20 | 21 | SMD504497-17 | 80063 | 21 | 4 |
| SMC508318 | 80063 | 21 | 12 | SMD504497-3 | 80063 | 20 | 4 |
| SMC508318 | 80063 | 22 | 2 | SMD504826-1 | 80063 | 24 | 15 |
| SMC508318 | 80063 | 23 | 7 | SMD504863 | 80063 | 2 | 22 |
| SMC508320-2 | 80063 | 12 | 6 | SMD505017 | 80063 | 10 | 12 |
| SMC508321 | 80063 | 23 | 2 | SMD505017 | 80063 | 11 | 16 |
| SMC508323 | 80063 | 3 | 22 | SMD505017 | 80063 | 12 | 19 |
| SMC508324 | 80063 | 4 | 6 | SMD505017 | 80063 | 13 | 21 |
| SMC508337 | 80063 | 5 | 35 | SMD505017 | 80063 | 14 | 45 |
| SMC508339 | 80063 | 22 | 21 | SMD505017 | 80063 | 19 | 23 |
| SMC508340-2 | 80063 | 19 | 12 | SMD508123-4 | 80063 | 11 | 38 |
| SMC508340-3 | 80063 | 13 | 3 | SMD508307 | 80063 | 7 | 16 |
| SMC508344-1 | 80063 | 2 | 17 | SMD508311 | 80063 | 20 | 14 |
| SMC508344-1 | 81349 | 25 | 5 | SMD508311 | 80063 | 21 | 14 |
| SMC508344-3 | 80063 | 2 | 15 | SMD508311 | 80063 | 22 | 7 |
| SMC508344-3 | 81349 | 25 | 1 | SMD508319 | 80063 | 2 | 10 |
| SMC508345 | 80063 | 3 | 15 | SMD508322 | 80063 | 8 | 12 |
| SMC508345 | 80063 | 24 | 9 | SMD508327 | 80063 | 10 | 18 |
| SMC508345 | 80063 | 24 | 13 | SMD508328 | 80063 | 3 | 18 |
| SMC508347-2 | 80063 | 24 | 21 | SMD508333 | 96906 | 4 | 14 |
| SMC508348 | 80063 | 24 | 7 | SMD508334 | 80063 | 53 | 13 |
| SMC508350-7 | 80063 | 24 | 20 | SMD508341-1 | 80063 | 5 | 4 |
| SMC508358 | 80063 | 4 | 4 | SMD508341-2 | 80063 | 25 | 7 |
| SMC508361-1 | 80063 | 2 | 7 | SMD508341-3 | 80063 | 25 | 26 |
| SMC508361-2 | 80063 | 2 | 6 | SMD508343 | 80063 | 3 | 12 |
| SMC508363-2 | 80063 | 8 | 5 | SMD508346 | 80063 | 21 | 27 |
| SMC508364-1 | 80063 | 7 | 20 | SMD508353-1 | 80063 | 12 | 5 |
| SMC508364-2 | 80063 | 7 | 18 | SMD508353-2 | 80063 | 12 | 39 |
| SMC508364-3 | 80063 | 7 | 13 | SMD508355 | 80063 | 3 | 16 |
| SMC508364-4 | 80063 | 7 | 14 | SMD508360-2 | 80063 | 2 | 21 |
| SMC508364-5 | 80063 | 7 | 19 | SMD508362 | 80063 | 25 | 15 |
| SMC508364-6 | 80063 | 7 | 17 | SMD508365-2 | 80063 | 5 | 21 |
| SMC508365-1 | 80063 | 5 | 25 | SMD508365-3 | 80063 | 6 | 29 |
| SMC508365-4 | 80063 | 25 | 13 | SMD508367-1 | 80063 | 8 | 22 |
| SMC508369 | 80063 | 8 | 17 | SMD508370-1 | 80063 | 11 | 39 |
| SMC508373 | 80063 | 3 | 1 | SMD508370-1 | 80063 | 12 | 2 |
| SMC508374 | 80063 | 25 | 30 | SMD508370-1 | 80063 | 13 | 37 |
| SMC508375 | 80063 | 5 | 37 | SMD508370-1 | 80063 | 14 | 48 |
| SMC508376 | 80063 | 24 | 11 | SMD508370-1 | 80063 | 15 | 24 |
| SMC508377-1 | 80063 | 5 | 30 | SMD508370-1 | 80063 | 16 | 16 |
| SMC508377-2 | 80063 | 5 | 29 | SMD508370-1 | 80063 | 17 | 24 |
| SMC508378 | 80063 | 25 | 36 | SMD508370-1 | 80063 | 20 | 22 |
| SMC508381 | 80063 | 25 | 33 | SMD508370-1 | 80063 | 21 | 22 |
| SMC508389 | 80063 | 25 | 14 | SMD508370-2 | 80063 | 19 | 7 |
| SMC508392 | 80063 | 20 | 11 | SMD508370-3 | 80063 | 11 | 40 |
| SMC508392 | 80063 | 21 | 11 | SMD508370-3 | 80063 | 12 | 42 |
| SMC508397 | 80063 | 20 | 17 | SMD508370-3 | 80063 | 13 | 38 |
| SMC508397 | 80063 | 21 | 17 | SMD508370-3 | 80063 | 14 | 47 |
| SMC508398-1 | 80063 | 8 | 20 | SMD508370-3 | 80063 | 15 | 25 |
| SMC508398-2 | 80063 | 5 | 38 | SMD508370-3 | 80063 | 16 | 17 |
| SMC508400 | 80063 | 3 | 9 | SMD508370-3 | 80063 | 17 | 26 |
| SMC508405 | 80063 | 6 | 1 | SMD508382 | 80063 | 5 | 15 |
| SMC508411-1 | 80063 | 2 | 35 | SMD508384 | 80063 | 22 | 37 |
| SMC508411-2 | 80063 | 5 | 22 | SMD508385-1 | 80063 | 5 | 16 |
| SMC508413-1 | 80063 | 14 | 31 | SMD508385-2 | 80063 | 3 | 6 |
| SMC508413-2 | 80063 | 7 | 5 | SMD508387 | 80063 | 19 | 32 |
| SMC508413-2 | 80063 | 10 | 6 | SMD508390 | 80063 | 20 | 28 |
| SMC508413-2 | 80063 | 13 | 7 | SMD508390 | 80063 | 21 | 28 |
| SMC508413-2 | 80063 | 14 | 26 | SMD508399 | 80063 | 10 | 1 |
| SMC508414 | 80063 | 2 | 33 | SMD508399 | 80063 | 11 | 1 |

| PART NUMBER | FSCM | FIG NO | ITEM NO | PART NUMBER | FSCM | FIG NO | ITEM NO |
|-------------|-------|--------|---------|---------------|-------|--------|---------|
| SMD508399 | 80063 | 12 | 1 | SMD508478 | 80063 | 9 | 1 |
| SMD508399 | 80063 | 13 | 1 | SMD508480 | 80063 | 9 | 6 |
| SMD508399 | 80063 | 14 | 1 | SMD508482 | 80063 | 17 | 28 |
| SMD508399 | 80063 | 15 | 1 | SMD508483 | 80063 | 9 | 8 |
| SMD508399 | 80063 | 16 | 1 | SMD508486 | 80063 | 9 | 11 |
| SMD508399 | 80063 | 17 | 1 | SMD508489 | 80063 | 19 | 28 |
| SMD508399 | 80063 | 18 | 1 | SMD508490 | 80063 | 9 | 14 |
| SMD508399 | 80063 | 19 | 1 | SMD508493 | 80063 | 9 | 12 |
| SMD508399 | 80063 | 20 | 1 | SMD508496 | 80063 | 9 | 9 |
| SMD508399 | 80063 | 21 | 1 | SMD508501 | 80063 | 23 | 5 |
| SMD508399 | 80063 | 22 | 1 | SMD508502 | 80063 | 9 | 10 |
| SMD508399 | 80063 | 23 | 1 | SMD508505 | 80063 | 16 | 18 |
| SMD508403 | 80063 | 25 | 29 | SMD508506 | 80063 | 9 | 7 |
| SMD508404 | 80063 | 3 | 19 | SMD508522 | 80063 | 25 | 23 |
| SMD508406 | 80063 | 3 | 21 | SMD508540 | 80063 | 25 | 22 |
| SMD508408-2 | 80063 | 25 | 31 | SMD508555-1 | 80063 | 14 | 24 |
| SMD508410 | 80063 | 3 | 17 | SMD508555-2 | 80063 | 11 | 32 |
| SMD508412-1 | 80063 | 10 | 23 | SMD508555-2 | 80063 | 14 | 33 |
| SMD508412-1 | 80063 | 19 | 20 | SMD508560 | 80063 | 5 | 1 |
| SMD508412-1 | 80063 | 20 | 10 | SME508308-1 | 80063 | 24 | 6 |
| SMD508412-1 | 80063 | 21 | 10 | SME508308-2 | 80063 | 24 | 2 |
| SMD508412-2 | 80063 | 12 | 15 | SME508444 | 80063 | 4 | 20 |
| SMD508412-2 | 80063 | 14 | 5 | SME508451 | 80063 | 6 | 16 |
| SMD508412-2 | 80063 | 18 | 18 | SME508452 | 80063 | 1 | 2 |
| SMD508412-3 | 80063 | 18 | 19 | SME508455 | 80063 | 1 | 1 |
| SMD508412-4 | 80063 | 11 | 18 | SME508456 | 80063 | 2 | 1 |
| SMD508412-4 | 80063 | 14 | 10 | SME508516 | 80063 | 25 | 8 |
| SMD508415 | 80063 | 11 | 17 | | | | |
| SMD508415 | 80063 | 12 | 14 | SOS440-6 | 46384 | 22 | 35 |
| SMD508415 | 80063 | 13 | 30 | TA50A6 | 84971 | 25 | 32 |
| SMD508415 | 80063 | 14 | 29 | TW516-10 | 08289 | 4 | 23 |
| SMD508415 | 80063 | 18 | 3 | UP131M | 81349 | 24 | 18 |
| SMD508415 | 80063 | 22 | 24 | 1N1095 | 81349 | 17 | 13 |
| SMD508417 | 80063 | 10 | 44 | 1N1096 | 81349 | 16 | 9 |
| SMD508417 | 80063 | 18 | 5 | 1N1202 | 81349 | 4 | 9 |
| SMD508424-1 | 80063 | 3 | 8 | 1N270 | 81349 | 22 | 22 |
| SMD508424-2 | 80063 | 4 | 15 | 1N276 | 81349 | 13 | 6 |
| SMD508431 | 80063 | 3 | 2 | 1N276 | 81349 | 14 | 2 |
| SMD508433-1 | 80063 | 11 | 2 | 1N2988A | 81349 | 4 | 10 |
| SMD508433-2 | 80063 | 11 | 3 | 1N3020B | 81349 | 13 | 40 |
| SMD508434 | 80063 | 18 | 28 | 1N3730 | 81349 | 6 | 9 |
| SMD508435-1 | 81349 | 14 | 13 | 1N645 | 81349 | 16 | 4 |
| SMD508435-1 | 81349 | 22 | 26 | 1N746A | 81349 | 17 | 14 |
| SMD508435-2 | 81349 | 14 | 50 | 1N751 | 81349 | 17 | 16 |
| SMD508436 | 80063 | 2 | 3 | 1N752 | 81349 | 15 | 13 |
| SMD508437 | 80063 | 25 | 6 | 1N754A | 81349 | 17 | 2 |
| SMD508438 | 80063 | 5 | 17 | 1N830A | 81349 | 7 | 6 |
| SMD508439 | 80063 | 19 | 33 | 1N830A | 81349 | 22 | 32 |
| SMD508439 | 80063 | 20 | 29 | 1N914 | 81349 | 19 | 11 |
| SMD508439 | 80063 | 21 | 29 | 10954-325 | 06773 | 4 | 1 |
| SMD508439 | 80063 | 22 | 38 | 2N1016B | 81349 | 7 | 12 |
| SMD508440-1 | 80063 | 5 | 18 | 2N1307 | 81349 | 15 | 19 |
| SMD508440-2 | 80063 | 5 | 14 | 2N1485 | 81349 | 6 | 7 |
| SMD508441-1 | 80063 | 15 | 12 | 2N1613 | 81349 | 15 | 5 |
| SMD508441-2 | 80063 | 15 | 8 | 2N1613 | 81349 | 17 | 8 |
| SMD508441-3 | 80063 | 8 | 18 | 2N174 | 81349 | 7 | 11 |
| SMD508442-1 | 80063 | 15 | 11 | 2N2219 | 81349 | 11 | 36 |
| SMD508442-1 | 80063 | 17 | 29 | 2N2219 | 81349 | 12 | 35 |
| SMD508442-2 | 80063 | 10 | 14 | 2N2219 | 81349 | 13 | 23 |
| SMD508442-3 | 80063 | 13 | 32 | 2N297A | 81349 | 17 | 22 |
| SMD508442-3 | 80063 | 14 | 16 | 2N329A | 81349 | 17 | 7 |
| SMD508442-3 | 80063 | 22 | 28 | 2N338 | 81349 | 12 | 37 |
| SMD508442-4 | 80063 | 7 | 3 | 2N338 | 81349 | 14 | 30 |
| SMD508442-4 | 80063 | 15 | 3 | 2N338 | 81349 | 19 | 4 |
| SMD508442-4 | 80063 | 16 | 5 | 2N706 | 81349 | 14 | 7 |
| SMD508442-4 | 80063 | 19 | 18 | 2104-02-2520N | 78189 | 6 | 6 |
| SMD508443 | 80063 | 5 | 13 | 302034700 | 91500 | 6 | 20 |
| SMD508445 | 80063 | 25 | 28 | 310-0046-00 | 79807 | 25 | 19 |
| SMD508447 | 80063 | 2 | 27 | 310-0048-00 | 79807 | 2 | 31 |
| SMD508454 | 80063 | 8 | 19 | 310004500 | 79807 | 5 | 19 |
| SMD508457 | 80063 | 11 | 41 | 310004600 | 79807 | 8 | 15 |
| SMD508459 | 80063 | 9 | 5 | 4AC1 | 91929 | 3 | 3 |
| SMD508461 | 80063 | 9 | 2 | 4548 | 71400 | 25 | 2 |
| SMD508464 | 80063 | 4 | 8 | 5409168003 | 13499 | 5 | 20 |
| SMD508465 | 80063 | 12 | 44 | 68M40 | 72962 | 6 | 24 |
| SMD508466 | 80063 | 4 | 12 | 68NM40 | 72962 | 4 | 2 |
| SMD508468 | 80063 | 9 | 4 | 68NM62 | 72962 | 8 | 16 |
| SMD508469 | 80063 | 13 | 41 | 68NM62 | 72962 | 25 | 20 |
| SMD508471 | 80063 | 9 | 3 | 7274633 | 16758 | 4 | 21 |
| SMD508475 | 80063 | 9 | 13 | 762-2169-001 | 13499 | 3 | 20 |

| PART NUMBER | FSCM | FIG NO | ITEM NO | PART NUMBER | FSCM | FIG NO | ITEM NO |
|-------------|-------|--------|---------|----------------|-------|--------|---------|
| 7622115001 | 13499 | 4 | 22 | 805014XV0103Z | 72982 | 22 | 4 |
| 7622171003 | 13499 | 6 | 30 | 805014X5V0103Z | 72982 | 11 | 23 |
| 7622196001 | 13499 | 7 | 2 | | | | |

LATEST NATIONAL STOCK NUMBER ASSIGNMENTS

| STOCK NUMBER | FIG NO | ITEM NO | STOCK NUMBER | FIG NO | ITEM NO |
|------------------|--------|---------|------------------|--------|---------|
| 5910-00-043-1996 | 14 | 52 | 5961-00-813-9360 | 17 | 8 |
| 5905-00-079-4382 | 18 | 24 | 5305-00-829-0105 | 5 | 31 |
| 5905-00-106-1356 | 12 | 25 | 5310-00-880-5978 | 25 | 17 |
| 5365-00-181-1371 | 3 | 20 | 5910-00-883-9671 | 12 | 43 |
| 5905-00-190-8879 | 13 | 25 | 5995-00-902-2071 | 1 | 5 |
| 5310-00-225-5328 | 2 | 31 | 5995-00-902-2078 | 1 | 7 |
| | | | 5995-00-902-8502 | 1 | 4 |
| | | | 5310-00-934-9761 | 25 | 25 |
| 5961-00-688-6316 | 16 | 9 | 5961-00-995-2310 | 15 | 13 |
| 5340-00-722-8713 | 5 | 20 | 5905-00-925-7172 | 12 | 11 |
| 5905-00-759-8896 | 16 | 15 | 5995-00-892-3393 | 10 | 19 |
| 5961-00-813-9360 | 15 | 5 | | | |

LATEST PART NUMBER ASSIGNMENTS

| PART NUMBER | FSCM | FIG. NO. | ITEM NO. |
|--------------|-------|----------|----------|
| CM107F103J03 | 81349 | 11 | 12 |
| RC07GF482J | 81349 | 14 | 8 |
| RC07GF102J | 81349 | 12 | 11 |

ADDITIONAL LATEST NATIONAL STOCK NUMBER ASSIGNMENTS

| STOCK NUMBER | FIG NO | ITEM NO | STOCK NUMBER | FIG NO | ITEM NO |
|------------------|--------|---------|------------------|--------|---------|
| 6240-00-080-2012 | 25 | 3 | 5905-00-110-8768 | 12 | 27 |
| 5905-00-110-7620 | 11 | 14 | 5905-00-110-8768 | 14 | 32 |
| 5905-00-110-7620 | 12 | 20 | 5995-00-902-4146 | 1 | 6 |
| 5905-00-110-7620 | 13 | 12 | 6625-00-902-7138 | 25 | 31 |
| 5905-00-110-7620 | 14 | 4 | 6625-00-902-7575 | 1 | 3 |
| 5905-00-110-7620 | 22 | 8 | 5905-01-013-8264 | 6 | 13 |

ADDITIONAL LATEST PART NUMBER ASSIGNMENTS

| PART NUMBER | FSCM | FIG NO | ITEM NO | PART NUMBER | FSCM | FIG NO | ITEM NO |
|-------------|-------|--------|---------|-------------|-------|--------|---------|
| RCR07G102JS | 81349 | 11 | 14 | RCR07G102JS | 81349 | 22 | 8 |
| RCR07G102JS | 81349 | 12 | 20 | RCR07G821JS | 81349 | 12 | 27 |
| RCR07G102JS | 81349 | 13 | 12 | RCR07G821JS | 81349 | 14 | 32 |
| RCR07G102JS | 81349 | 14 | 4 | RV6NAYS102B | 81349 | 6 | 13 |

RECOMMENDED CHANGES TO EQUIPMENT TECHNICAL PUBLICATIONS



THEN... JOT DOWN THE DOPE ABOUT IT ON THIS FORM. CAREFULLY TEAR IT OUT, FOLD IT AND DROP IT IN THE MAIL!

SOMETHING WRONG WITH THIS PUBLICATION?

FROM: (PRINT YOUR UNIT'S COMPLETE ADDRESS)
 Commander
 Stateside Army Depot
 ATTN: AMSTA-US
 Stateside, NJ 07703

DATE SENT
 10 July 1975

| | | |
|--|-------------------------------|--|
| PUBLICATION NUMBER TM 11-5840-340-20P | PUBLICATION DATE 23 Jan 78 | PUBLICATION TITLE Radar Set AN/PRG-76 |
|--|-------------------------------|--|

| BE EXACT... PIN-POINT WHERE IT IS | | | | IN THIS SPACE TELL WHAT IS WRONG AND WHAT SHOULD BE DONE ABOUT IT: |
|-----------------------------------|------------|-----------|----------|---|
| PAGE NO | PARA-GRAPH | FIGURE NO | TABLE NO | |
| 33 | | | | For item 2, change the NSN to read: 5835-00-134-9186. <u>Reason:</u> Accuracy. |
| 44 | | 19 | | Identify the cover on the junction box (item no 5) <u>Reason:</u> It is a separate item and is not called out on figure 19 |
| 45 | | | | Add the cover of the junction box as an item in the listing for figure 19. <u>Reason:</u> Same as above. |

SAMPLE

PRINTED NAME, GRADE OR TITLE, AND TELEPHONE NUMBER
 SSG I. M. DeSpirito 999-1776

SIGN HERE:
SSG I. M. DeSpirito

DA FORM 2028-2 JUL 78

PREVIOUS EDITIONS ARE OBSOLETE.

P.S.--IF YOUR OUTFIT WANTS TO KNOW ABOUT YOUR RECOMMENDATION MAKE A CARBON COPY OF THIS AND GIVE IT TO YOUR HEADQUARTERS.

TEAR ALONG PERFORATED LINE

FILL IN YOUR
UNIT'S ADDRESS

FOLD BACK

DEPARTMENT OF THE ARMY

OFFICIAL BUSINESS
PENALTY FOR PRIVATE USE \$300

POSTAGE AND FEES PAID
DEPARTMENT OF THE ARMY
DOD 314



Commander
US Army Communications and
Electronics Materiel Readiness Command
ATTN: DRSEL-ME-MQ
Fort Monmouth, New Jersey 07703

TEAM ALONG PERFORATED LINE

RECOMMENDED CHANGES TO EQUIPMENT TECHNICAL PUBLICATIONS



THEN... JOT DOWN THE DOPE ABOUT IT ON THIS FORM. CAREFULLY TEAR IT OUT. FOLD IT AND DROP IT IN THE MAIL!

SOMETHING WRONG WITH THIS PUBLICATION?

FROM: (PRINT YOUR UNIT'S COMPLETE ADDRESS)

DATE SENT

PUBLICATION NUMBER
TM 11-6625-467-24P

PUBLICATION DATE
23 Jun 80

PUBLICATION TITLE Test Set, Electronic
Circuit Plug-In Unit AN/ARM-87

BE EXACT... PIN-POINT WHERE IT IS

| PAGE NO | PARA-GRAPH | FIGURE NO | TABLE NO |
|---------|------------|-----------|----------|
| | | | |

IN THIS SPACE TELL WHAT IS WRONG AND WHAT SHOULD BE DONE ABOUT IT:

TEAR ALONG PERFORATED LINE

PRINTED NAME, GRADE OR TITLE, AND TELEPHONE NUMBER

SIGN HERE:

DA FORM 2028-2
1 JUL 79

PREVIOUS EDITIONS ARE OBSOLETE.

P.S.—IF YOUR OUTFIT WANTS TO KNOW ABOUT YOUR RECOMMENDATION MAKE A CARBON COPY OF THIS AND GIVE IT TO YOUR HEADQUARTERS

FILL IN YOUR
UNIT'S ADDRESS

FOLD BACK

DEPARTMENT OF THE ARMY

OFFICIAL BUSINESS
PENALTY FOR PRIVATE USE \$300

POSTAGE AND FEES PAID
DEPARTMENT OF THE ARMY
DOD 314



Commander
US Army Communications and
Electronics Materiel Readiness Command
ATTN: DRSEL -ME-MQ
Fort Monmouth, New Jersey 07703

TEAM ALONG PERFORATED LINE

RECOMMENDED CHANGES TO EQUIPMENT TECHNICAL PUBLICATIONS



SOMETHING WRONG WITH THIS PUBLICATION?

THEN... JOT DOWN THE DOPE ABOUT IT ON THIS FORM, CAREFULLY TEAR IT OUT, FOLD IT AND DROP IT IN THE MAIL!

FROM: (PRINT YOUR UNIT'S COMPLETE ADDRESS)

DATE SENT

| | | |
|--|-------------------------------|--|
| PUBLICATION NUMBER TM 11-6625-467-24P | PUBLICATION DATE 23 Jun 80 | PUBLICATION TITLE Test Set, Electronic Circuit Plug-In Unit AN/ARM-87 |
|--|-------------------------------|--|

| BE EXACT... PIN-POINT WHERE IT IS | | | | IN THIS SPACE TELL WHAT IS WRONG AND WHAT SHOULD BE DONE ABOUT IT: |
|-----------------------------------|------------|-----------|----------|--|
| PAGE NO | PARA-GRAPH | FIGURE NO | TABLE NO | |
| | | | | |

| | |
|--|------------|
| PRINTED NAME, GRADE OR TITLE, AND TELEPHONE NUMBER | SIGN HERE: |
|--|------------|

TEAR ALONG PERFORATED LINE

FILL IN YOUR
UNIT'S ADDRESS

FOLD BACK

DEPARTMENT OF THE ARMY

OFFICIAL BUSINESS
PENALTY FOR PRIVATE USE \$300

POSTAGE AND FEES PAID
DEPARTMENT OF THE ARMY
DOD 314



Commander
US Army Communications and
Electronics Materiel Readiness Command
ATTN: DRSEL-ME-MQ
Fort Monmouth, New Jersey 07703

TEAR ALONG PERFORATED LINE

RECOMMENDED CHANGES TO EQUIPMENT TECHNICAL PUBLICATIONS



SOMETHING WRONG WITH THIS PUBLICATION?

THEN... JOT DOWN THE DOPE ABOUT IT ON THIS FORM, CAREFULLY TEAR IT OUT, FOLD IT AND DROP IT IN THE MAIL'

FROM: (PRINT YOUR UNIT'S COMPLETE ADDRESS)

DATE SENT

PUBLICATION NUMBER

TM 11-6625-467-24P

PUBLICATION DATE

23 Jun 80

PUBLICATION TITLE Test Set, Electronic Circuit Plug-In Unit AN/ARM-87

BE EXACT... PIN-POINT WHERE IT IS

PAGE NO.

PARA-GRAPH

FIGURE NO.

TABLE NO.

IN THIS SPACE TELL WHAT IS WRONG AND WHAT SHOULD BE DONE ABOUT IT:

TEAR ALONG PERFORATED LINE

PRINTED NAME, GRADE OR TITLE, AND TELEPHONE NUMBER

SIGN HERE:

DA FORM 2028-2
1 JUL 79

PREVIOUS EDITIONS ARE OBSOLETE.

P.S.—IF YOUR OUTFIT WANTS TO KNOW ABOUT YOUR RECOMMENDATION MAKE A CARBON COPY OF THIS AND GIVE IT TO YOUR HEADQUARTERS.

FILL IN YOUR
UNIT'S ADDRESS

FOLD BACK

DEPARTMENT OF THE ARMY

OFFICIAL BUSINESS
PENALTY FOR PRIVATE USE \$300

POSTAGE AND FEES PAID
DEPARTMENT OF THE ARMY
DOD 314



Commander
US Army Communications and
Electronics Materiel Readiness Command
ATTN: DRSEL -ME-MQ
Fort Monmouth, New Jersey 07703

TEAR ALONG PERFORATED LINE

By Order of the Secretary of the Army:

Official:

J. C. PENNINGTON

*Major General, United States Army
The Adjutant General*

E. C. MEYER
*General, United States Army
Chief of Staff*

Distribution:

To be distributed in accordance with DA Form 12-36A Organizational maintenance requirements for AN/ARM-87.

